

RTVS1

TRANSFORMER FAN SPEED
CONTROLLER WITH MODBUS
RTU COMMUNICATION

Mounting and operating instructions



Table of contents

SAFETY AND PRECAUTIONS	3
PRODUCT DESCRIPTION	4
ARTICLE CODES	4
INTENDED AREA OF USE	4
TECHNICAL DATA	4
STANDARDS	4
WIRING AND CONNECTIONS	5
MOUNTING INSTRUCTIONS IN STEPS	6
OPERATING INSTRUCTIONS	9
VERIFICATION OF INSTALLATION	11
TRANSPORT AND STORAGE	12
WARRANTY AND RESTRICTIONS	12
MAINTENANCE	12

SAFETY AND PRECAUTIONS



Read all the information, the datasheet, Modbus map, mounting and operating instructions and study the wiring and connection diagram before working with the product. For personal and equipment safety, and for optimum product performance, make sure you entirely understand the contents before installing, using, or maintaining this product.



For safety and licensing (CE) reasons, unauthorised conversion and /or modifications of the product are inadmissible.



The product should not be exposed to abnormal conditions, such as extreme temperatures, direct sunlight or vibrations. Long-term exposure to chemical vapours in high concentration can affect the product performance. Make sure the work environment is as dry as possible; avoid condensation.



All installations shall comply with local health and safety regulations and local electrical standards and approved codes. This product can only be installed by an engineer or a technician who has expert knowledge of the product and safety precautions.



Avoid contacts with energised electrical parts. Always disconnect the power supply before connecting, servicing or repairing the product.



Always verify that you apply appropriate power supply to the product and use appropriate wire size and characteristics. Make sure that all the screws and nuts are well tightened and fuses (if any) are fitted well.



Recycling of equipment and packaging should be taken into consideration and these should be disposed of in accordance with local and national legislation / regulations.



In case there are any questions that are not answered, please contact your technical support or consult a professional.

PRODUCT DESCRIPTION

The RTVS1 series of transformer fan speed controllers regulate the rotational speed of single-phase voltage controllable motors in five steps by varying the output voltage. They are equipped with auto-transformer(s) and feature Modbus RTU communication, TK monitoring for thermal motor protection.

ARTICLE CODES

Article code	Rated max. current [A]	Fuse [A]	Current rating, no load [A]
RTVS1-15L22	1,5	T-2,5 A-H	0,04
RTVS1-25L22	2,5	T-4 A-H	0,06
RTVS1-35L22	3,5	T-5 A-H	0,08
RTVS1-50L22	5	T-8 A-H	0,1
RTVS1-75L22	7,5	T-10 A-H	0,12

INTENDED AREA OF USE

- Fan speed control of voltage controllable motors (pumps and fans) in ventilation systems
- Demand based ventilation in greenhouses, sheds and stables.
- Ventilation based on temperature, relative humidity, carbon dioxide, air quality (TVOC) or carbon monoxide*
- For indoor use, surface mounted

*Selection can be made via RTVS1 Modbus holding register 20.

TECHNICAL DATA

- Supply voltage: 230 VAC / 50–60 Hz
- Modbus RTU communication
- TK monitoring for thermal motor protection
- Operating modes:
 - ▶ Automatic (from low to high or from high to low): Fan speed based on input from external Sentera sensor or potentiometer connected to the RJ45 master socket
 - ▶ Manual: Fan speed based on user input via Modbus Holding Register 12
- Selectable output update interval from 5 s to 10 min
- LED status indication
- Modbus RTU communication via RJ45 connectors
- Unregulated output 230 VAC (I max 16 A, resistive load)
- Bootloader for uploading new firmware via Modbus RTU
- Enclosure: plastic (R-ABS, UL94-V0, grey RAL 7035)
- Protection standard: IP54 (according to EN 60529)
- Operating ambient conditions:
 - ▶ Temperature: -10–35 °C
 - ▶ Rel. humidity: 5–85 % rH (non-condensing)

STANDARDS

- Low Voltage Directive 2014/35/EC:
 - ▶ EN 60529:1991 Degrees of protection provided by en-closures (IP Code) Amendment AC:1993 to EN 60529
 - ▶ EN 60730-1:2011 Automatic electrical controls for household and similar use - Part 1: General requirements
- EMC Directive 2014/30/EC: 

- ▶ EN 60730-1:2011 Automatic electrical controls for household and similar use - Part 1: General requirements
- ▶ EN 61000-6-1:2007 Electromagnetic compatibility (EMC) - Part 6-1: Generic standards - Immunity for residential, commercial and light-industrial environments
- ▶ EN 61000-6-3:2007 Electromagnetic compatibility (EMC) - Part 6-3: Generic standards - Emission standard for residential, commercial and light-industrial environments Amendments A1:2011 and AC:2012 to EN 61000-6-3
- WEEE Directive 2012/19/EC
- RoHs Directive 2011/65/EC

WIRING AND CONNECTIONS

<i>Terminal block</i>		
N	MOTOR	Regulated output to motor, neutral
L		Regulated output to motor, line
Pe		Protective earth terminal
N	RELAY	Unregulated output 230 VAC that can be set manually (ON / OFF) or automatically via Modbus Holding register 19 and 15.
L		
N	INPUT	Power supply, neutral
L		Power supply, phase (230 VAC / 50–60 Hz)
TK		Input - TK monitoring for thermal motor protection
TK		
<i>RJ45 master socket - to connect a Sentera sensor-transmitter for demand based control, or a digital potentiometer for manual control</i>		
Pin 1	24 VDC	Supply voltage
Pin 2		
Pin 3	A	Modbus RTU communication, signal A
Pin 4		
Pin 5	/B	Modbus RTU communication, signal /B
Pin 6		
Pin 7	GND	Ground, supply voltage
Pin 8		
<i>RJ45 gateway - to connect a computer with 3SModbus software, a Sentera internet gateway or a BMS system</i>		
Pin 1		Do not connect to your computer
Pin 2		
Pin 3	A	Modbus RTU communication, signal A
Pin 4		
Pin 5	/B	Modbus RTU communication, signal /B
Pin 6		
Pin 7		Do not connect to your computer
Pin 8		

ATTENTION

Make sure you use cables with an appropriate diameter.

MOUNTING INSTRUCTIONS IN STEPS

Before you start mounting the unit, read carefully **"Safety and Precautions"** and follow these steps. Choose a smooth solid surface for installation (a wall, panel, etc.).

Follow these steps:

1. Unscrew the front cover and open the enclosure. Mind the flat cable that connect the LEDs with the printed circuit board.
2. Fix the unit onto the wall or panel using the provided screws and dowels. Mind the correct mounting position and unit mounting dimensions. (See **Fig. 1 Mounting dimensions** and **Fig. 2 Mounting position**.)
3. Pay attention to the following instructions in order to minimize the operating temperature:
 - 3.1 Respect the distances both between the wall / ceiling and the device and between two devices as shown in **Fig. 2**. In order to ensure sufficient ventilation of the controller, clearance on every side has to be maintained.
 - 3.2 When installing the device, please keep in mind that the higher you install it, the warmer the device will get. For example, in a technical room the correct installation height can be of great importance. Do not install the controller above heating equipment or heat sources.
 - 3.3 If maximum ambient temperature cannot be adhered to, please provide extra forced ventilation / cooling.

Not respecting the abovelisted rules can reduce service life and relieves the manufacturer of any responsibilities.

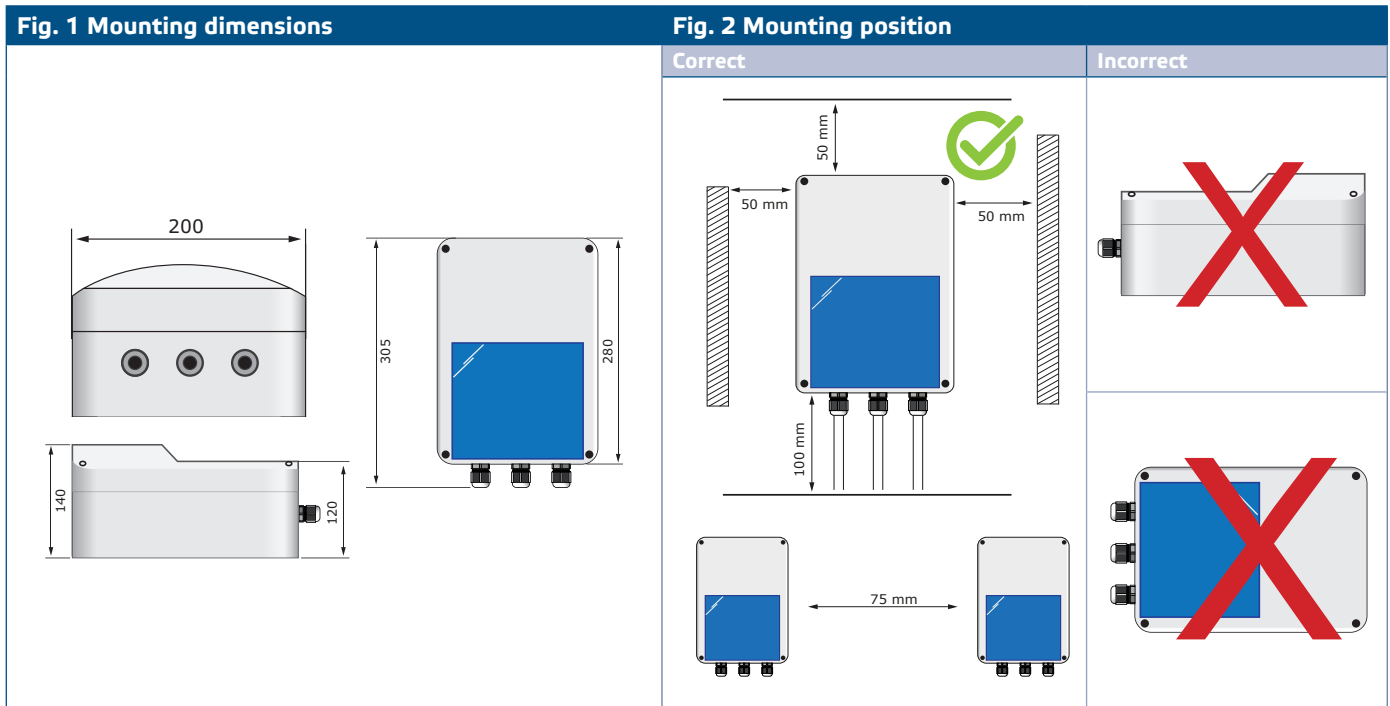

4. Insert the cables through the cable glands and do the wiring according to the wiring diagram (see **Fig. 3**) while adhering to the information from section **"Wiring and connections"** above.
 - 4.1 Connect the power supply line (terminals L, N marked as INPUT and Pe);
 - 4.2 Connect the motor terminals (L and N marked as MOTOR and Pe);

- 4.3 If applicable, connect the unregulated output (L and N marked as RELAY). The relay output contacts are Normal Open (NO) type - 16 A resistive with 230 VAC supply. The functionality of the unregulated output can be selected via Modbus through Holding register 19. By default (factory setting), the unregulated output indicates alarm conditions and can be used for connecting an alarm indication device - e.g. a lamp, buzzer, etc.
- 4.4 Connect the TK contacts for monitoring of the thermal motor protection to the motor TK terminals.

ATTENTION

A safety isolator / disconnect switch should be installed on the mains electricity side of all motor drives.

Fig. 3 Wiring and connections

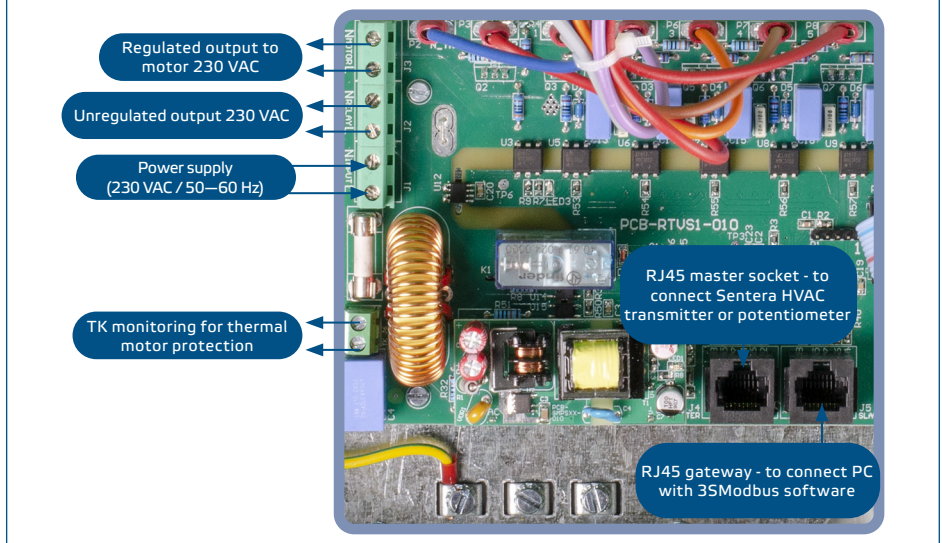

ATTENTION

Make sure the connections are correct before you power the unit.

- 5. Close the cover and secure it with the screws.
- 6. Tighten the cable glands.
- 7. Switch on the mains supply.
- 8. Customise the factory settings to the desired ones via the 3SModbus software or Sensistant. For the default factory setting, see the *Modbus register map*. The desired fan speed can be modified via Modbus holding register 12, or set automatically via Modbus holding register 18, according to connected sensor output value.

NOTE

For the complete Modbus register data, refer to the product Modbus Register Map, which is a separate document attached to the article code on the website and contains the registers list.

Optional settings

- 1. In automatic mode, a Sentera potentiometer with Modbus RTU communication can be connected to RTVS1. To obtain demand based fan speed control, RTVS1 can be combined with a Sentera HVAC sensor. The combination of RTVS1 with a Sentera HVAC transmitter allows you to control fan speed in function of temperature, relative humidity, carbon dioxide, air quality (TVOC) or carbon monoxide. The controlled parameter can be selected in RTVS1 Modbus holding register 18.
Crimp the RJ45 cable for the Modbus Master connector and plug it into the

socket. It is used to connect RTVS1 to a Sentera transmitter, intelligent sensor or sensor controller. Consult our website for compatible devices.

2. Crimp the RJ45 cable for the gateway connector and plug it into the socket. It is used to connect the unit to a PC or another master device for monitoring or manual control via Modbus holding register 12. To do so, you will need Sentera's Modbus to USB converter [CNVT-USB-RS485-V2](#). To modify or monitor parameters of a Sentera device via Modbus RTU, we advise using the 3SModbus software.

The 3SModbus software is free and can be downloaded via our website: <https://www.sentera.eu/en/3SMCenter> and installed on your computer. The Modbus to USB converter [CNVT-USB-RS485-V2](#) allows you to connect a Sentera device to the USB port of your computer and to monitor or adjust the different parameters - see **Application examples 1 and 2**.

Application example 1: Manual mode - control via Modbus holding register 14



Application example 2: Automatic mode - demand based ventilation



3. To assure correct communication, the NBT needs to be activated in only two devices on the Modbus RTU network. If necessary, enable the NBT resistor via 3SModbus or Sensistant (*Holding register 9*).

Example 1

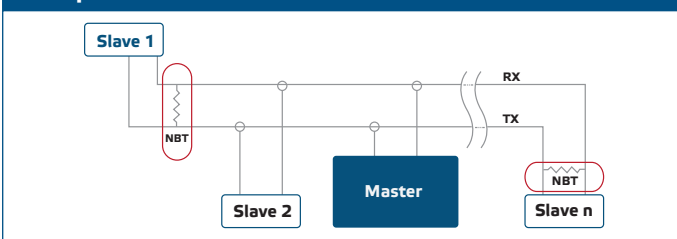

Example 2

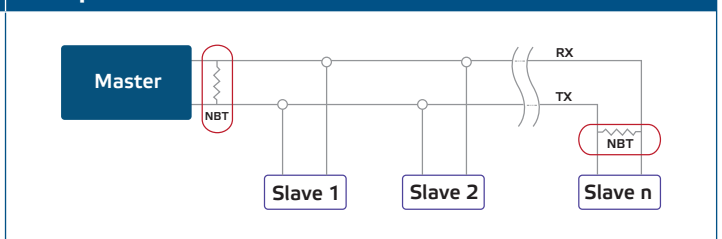

NOTE

On a Modbus RTU network, two bus terminators (NBTs) need to be activated.

CAUTION

Do not expose to direct sunlight!

Voltage steps selection

The standard configuration of the output voltages automatic mode is as indicated

in **Table 1** below. The threshold levels at which each step activates is selected via Modbus holding registers from 21 to 25. Each of these levels represents the value above which step is activated.

Table 1 Voltage steps						
Steps*	0	1	2	3	4	5
Auto forward mode default values	0 %	17 %	34 %	51 %	68 %	85 %
Auto reverse mode default values	-	0 %	75 %	50 %	25 %	1 %

* Each level can take a value from 0 to 100 %.

OPERATING INSTRUCTIONS



NOTE

On start-up the green COM LED blinks fast for 15 seconds to indicate that the device is initialising.



ATTENTION

- Make sure the connections are correct before you power the unit.
- Make sure the mains supply voltage is within the admissible rated maximum current of the product.

- Switch off the mains power supply before connecting any power cables.
- Install the connected sensor in an appropriate zone in order to measure the relevant ambient conditions.
- Select the operating mode via Modbus Holding Register 11. The default mode is **Automatic forward mode**.

3.1 Manual mode

The value is taken by Holding Register 12, where you can set the desired output step (see the steps and corresponding voltages in Table 1 above.)

3.2 Automatic modes

When Auto mode has been selected, the controller changes the five speeds automatically according to the values measured by the sensor connected to the RJ45 master socket. There are two automatic modes:

3.2.1 Automatic forward mode. See operational digram below:

Each level can take value from 0 to 100 % with the following restrictions: 0 = OFF, i.e. the step is skipped. Foreexample: Step 1 = 17%, Step 2 = 34%, Step 3 = 0%, Step 4 = 68%, Step 5 = 85%, from 34 to 68% the device will be in Step 2 and above 68% - in Step 4. Each step threshold restricts by the steps above and below with minimum of 11% difference, so when the hysteresis is set at 10% the thresholds will not overlap. For example: Step 1 = 17 %, Step 2 = 34 %, Step 3 = 51 %, Step 2 can take values from 28 % to 40 %. The Hysteresis delta is asymmetric, valid when the input value is transitioning from high to low values. The device will subtract the value of Δ from the step threshold and the step will change below the resulting value. For example: Step 3 = 51 % threshold, Hysteresis delta = 2 %, Step 3 will be ON above 51% and OFF below 49 %. An example of forward switching mode when Min Step = 0 and Max Step = 5 is given in **Fig. 4** below. The thresholds are at 17 % and hysteresis delta is set from 2 to 10 % via Holding Register 16 (see **Fig. 4**).

Fig. 4 Automatic mode 'forward': Low to high speed

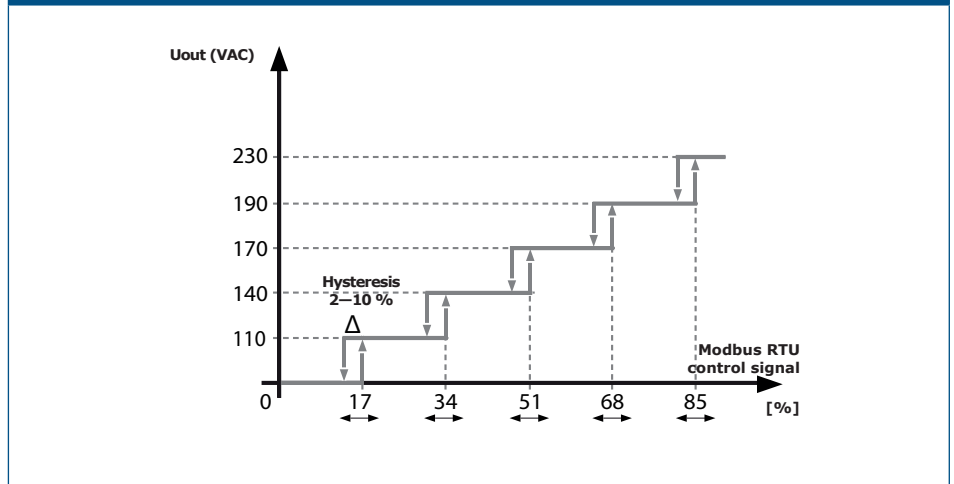

3.2.2 Automatic reverse mode. See operational digram below:

The higher the Input value, the lower the output. See the operational diagram below for an example with steps from 2 to 5. An example of Auto Reverse mode, the steps threshold configuration is as follows: Step 1 – 0 %, Step 2 – 75 %, Step 3 – 50 %, Step 4 – 25 %, Step 5 – 1 % (can be as low as 0,1 %) is given in **Fig. 5** below. When the Input value is above 1%, device switches to Step 5, above 25 % Step 4, above 50 % Step 3, above 75 % Step 2 up to 100 %. When the Input value decreases, the hysteresis delta is subtracted from the threshold level and the device changes the step (see **Fig. 5**).

Fig. 5 Automatic mode 'reverse': High to low speed

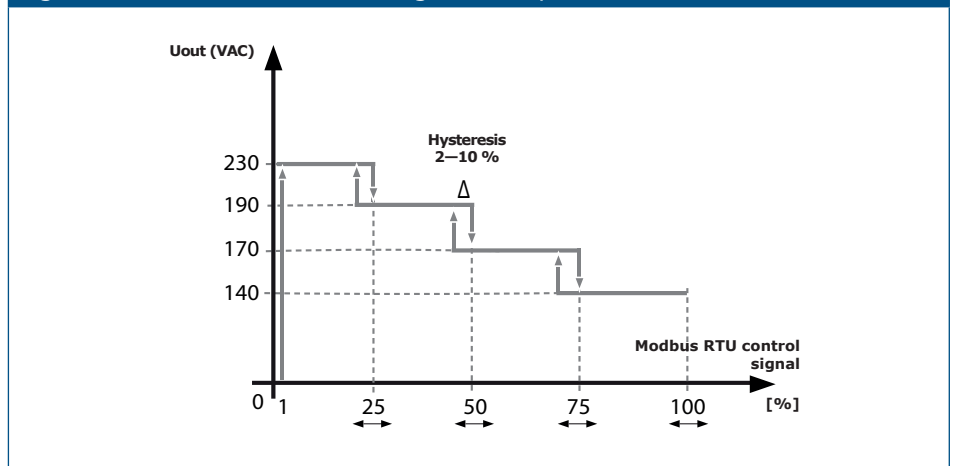

Explanation of specific Modbus registers

The unit has factory pre-set parameters written in Modbus map. It can function without any other settings. However, there are some special registers you may need to set depending on you combination of products. These are listed in **Table 2** below.

Table 2 Voltage steps

Modbus holding registers		Description	Values	Remark
11	Control Set	Automatic control – takes value from sensor. Manual Control – takes value from register 12	Auto Forward mode; Manual mode; Auto Reverse mode	It is possible to change the control of the article only when the switching of the current command has finished.
13	Output Update Interval	Time delay to update the output in automatic mode	5 s–600 s	If the value of the sensor connected is changing too fast this is the register that provides control of the time between two consecutive switching.
16	Hysteresis delta	The difference between the upwards switching and downwards switching step percentage	2–10 %	This value is subtracted from the threshold when the article is switching from high to low input value. Hysteresis value is 2 – 10%, it means for threshold 20%, the “threshold – hysteresis” = 18% for Δ = 2%.
17	Communication Lost Output State	Set output when Modbus communication is lost	OFF; Last step selected	Set to 0 = OFF, when there is Modbus Timeout set, when the device encounters Timeout - RTVS1 enters STOP mode, output is 0. If the remote sensor is lost – device enters state 0 = OFF. Both communications lost, article goes to OFF. When set to 1 = Last step selected, on Modbus Timeout occurrence and sensor is connected – article continues to operate in regarding of the input from the sensor, if sensor is lost – the article stays on the last step selected. If both communications are lost, device stays on the last step selected. In Auto modes, if there is no communication to the control/monitoring station, the article continues to operate autonomously while the sensor is connected.
18	Sensor output register value number	Select which sensor output will be used as input to the device	Digital potentiometer; Temperature; Relative Humidity; CO ₂ /CO ₂ eq; CO/TVOC; NO ₂	Sensor output register value number, define which sensor value will be taken for control of the device switching. The restrictions that apply are for Sentera Sensors only, and the SPV device. When SPV device is connected this value becomes automatically 1 and cannot be changed until other sensor is connected.
21–25	Input value step 1–5	Input value to switch to output steps 1–5	Switches to output step X at X % input value and steps down to output previous step at X % - Hysteresis delta (HR16) set	Input Value Step X – the steps will be activated over these thresholds. If register value is 0 – this step will be skipped as a holding step, but it will be used as intermediate step if needed to switch to upper/lower step. Minimum difference between steps thresholds is 11%, that way any overlapping of the switching and the hysteresis is avoided.

VERIFICATION OF INSTALLATION



ATTENTION

Use only tools and equipment with non-conducting handles when working on electrical devices.

Safe operation depends on proper installation. Before start up, ensure the following:

- The mains supply is connected correctly.
- Protection is provided against electrical shock.
- The cables are the appropriate size and fuse-protected.
- There is sufficient air flow around the unit.



ATTENTION

The unit is supplied with electrical energy at voltages high enough to inflict personal injury or threat to health. Take the relevant safety measures.



ATTENTION

Disconnect and confirm that there is no live current flowing to the unit before servicing.



ATTENTION

Avoid exposing the controller to direct sunlight!

TRANSPORT AND STORAGE

Avoid shocks and extreme conditions; stock in original packing.

WARRANTY AND RESTRICTIONS

Two years from the delivery date against defects in manufacturing. Any modifications or alterations to the product after the date of publication relieve the manufacturer of any responsibilities. The manufacturer bears no responsibility for any misprints or mistakes in this data.

MAINTENANCE

In normal conditions this product is maintenance-free. If soiled, clean with a dry or damp cloth. In case of heavy pollution, clean with a non-aggressive product. In these circumstances the unit should be disconnected from the supply. Pay attention that no fluids enter the unit. Only reconnect it to the supply when it is completely dry.