

# RSVCH-R | AIR QUALITY ROOM TRANSMITTER

Mounting and operating instructions



# Table of contents

<b>SAFETY AND PRECAUTIONS</b>	<b>3</b>
<b>PRODUCT DESCRIPTION</b>	<b>4</b>
<b>ARTICLE CODE</b>	<b>4</b>
<b>INTENDED AREA OF USE</b>	<b>4</b>
<b>TECHNICAL DATA</b>	<b>4</b>
<b>STANDARDS</b>	<b>4</b>
<b>OPERATIONAL DIAGRAMS</b>	<b>5</b>
<b>WIRING AND CONNECTIONS</b>	<b>6</b>
<b>MOUNTING INSTRUCTIONS IN STEPS</b>	<b>6</b>
<b>OPERATING INSTRUCTIONS</b>	<b>9</b>
<b>verification of installation</b>	<b>10</b>
<b>TRANSPORT AND STORAGE</b>	<b>10</b>
<b>WARRANTY AND RESTRICTIONS</b>	<b>10</b>
<b>MAINTENANCE</b>	<b>10</b>

## SAFETY AND PRECAUTIONS



Read all the information, the datasheet, Modbus map, mounting and operating instructions and study the wiring and connection diagram before working with the product. For personal and equipment safety, and for optimum product performance, make sure you entirely understand the contents before installing, using, or maintaining this product.



For safety and licensing (CE) reasons, unauthorised conversion and /or modifications of the product are inadmissible.



The product should not be exposed to abnormal conditions, such as extreme temperatures, direct sunlight or vibrations. Long-term exposure to chemical vapours in high concentration can affect the product performance. Make sure the work environment is as dry as possible; avoid condensation.



All installations shall comply with local health and safety regulations and local electrical standards and approved codes. This product can only be installed by an engineer or a technician who has expert knowledge of the product and safety precautions.



Avoid contacts with energised electrical parts. Always disconnect the power supply before connecting, servicing or repairing the product.



Always verify that you apply appropriate power supply to the product and use appropriate wire size and characteristics. Make sure that all the screws and nuts are well tightened and fuses (if any) are fitted well.



Recycling of equipment and packaging should be taken into consideration and these should be disposed of in accordance with local and national legislation / regulations.



In case there are any questions that are not answered, please contact your technical support or consult a professional.

## PRODUCT DESCRIPTION

RSVCH-R are multifunctional room transmitters which measure temperature, relative humidity and a broad range of total volatile organic compounds (TVOCs). The TVOC concentration is an accurate indicator for indoor air quality. Based on the temperature and relative humidity measurements, the dew-point temperature is calculated. They feature 24 VDC power supply and 3 analogue / modulating outputs - one for temperature, one for relative humidity and one for TVOC. All the parameters and measurements are accessible via Modbus RTU

## ARTICLE CODE

Code	Supply	I <sub>max</sub>	Connection
<b>RSVCH-R</b>	24 VDC	115 mA	RJ45 or terminal block

## INTENDED AREA OF USE

- Measurement of indoor temperature, relative humidity and TVOC
- Monitoring of indoor air quality
- Suitable for residential and commercial buildings
- For indoor use only

## TECHNICAL DATA

- Spring contact terminal block or RJ45 connections
- 3 analogue / modulating outputs:
  - ▶ 0–10 VDC mode: min. load 50 kΩ ( $R_L \geq 50 \text{ k}\Omega$ )
  - ▶ 0–20 mA mode: max. load 500 Ω ( $R_L \leq 500 \Omega$ )
  - ▶ PWM (open-collector type) mode: PWM Frequency: 1 kHz, min. load 50 kΩ ( $R_L \geq 50 \text{ k}\Omega$ ); PWM voltage level 3,3 VDC or 12 VDC
- Selectable temperature range: 0–50 °C
- Selectable relative humidity range: 0–100 % rH
- Warm-up time: 15 minutes
- Ambient light sensor with adjustable 'active' and 'standby' level
- Replaceable TVOC sensor module
- 3 LEDs with adjustable light intensity for status indication
- Accuracy: ±0,4 °C (0–50 °C); ±3 % rH (0–100 % rH); ±15% of measured TVOC (1–60.000 ppb TVOC), depending on the selected parameter
- Enclosure:
  - ▶ rear plate: plastic ABS, black (RAL 9004)
  - ▶ front cover: ASA, ivory (RAL 9010)
- Protection standard: IP30 (according to EN 60529)
- Operating ambient conditions:
  - ▶ temperature: 0–50 °C
  - ▶ rel. humidity: 0–100 % rH (non-condensing)
- Storage temperature: -10–60 °C

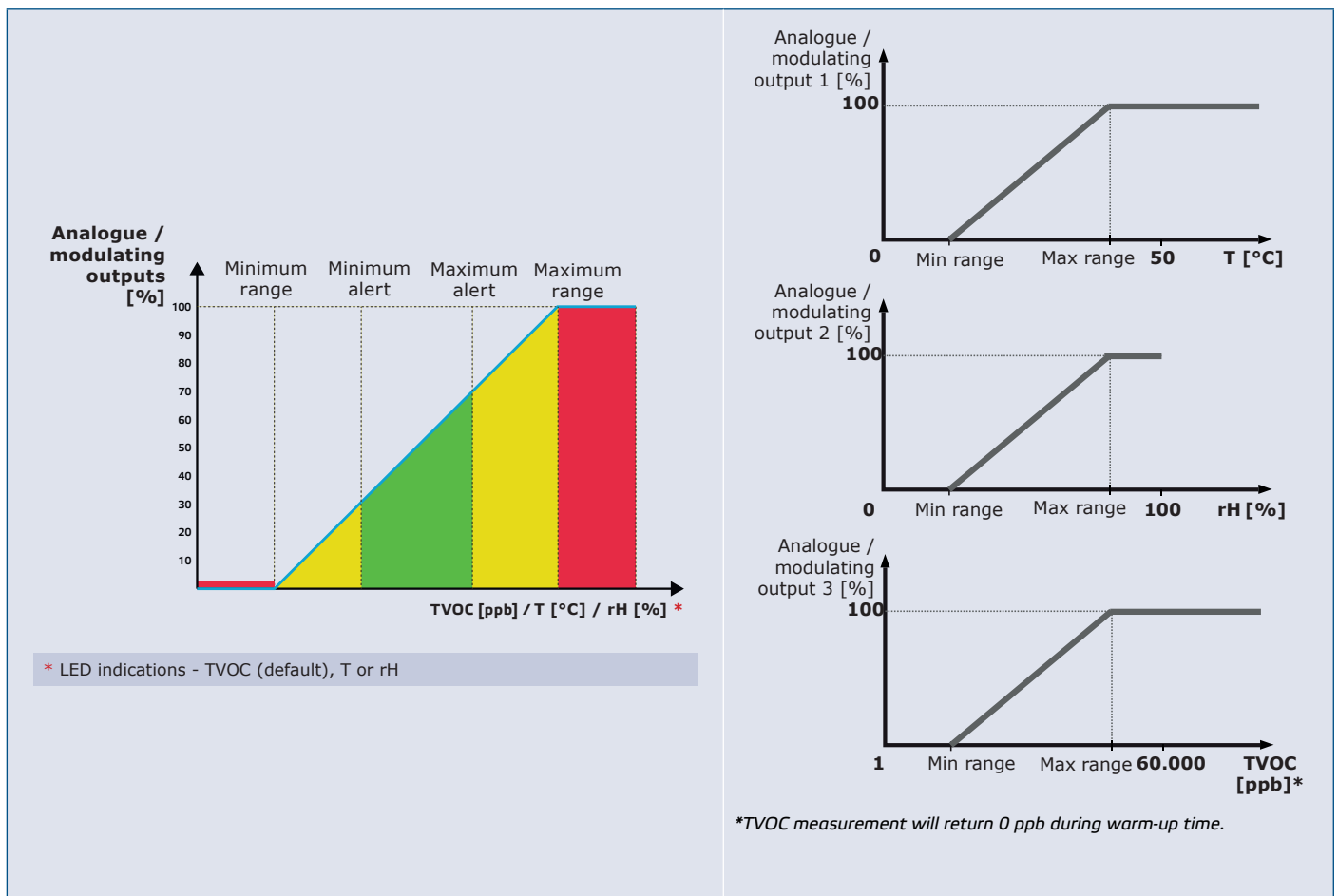
## STANDARDS

- EMC directive 2014/30/EU:
  - ▶ EN 60730-1:2011 Automatic electrical controls for household and similar use - Part 1: General requirements
  - ▶ EN 61000-6-1:2007 Electromagnetic compatibility (EMC) - Part 6-1: Generic standards — Immunity for residential, commercial and light industrial environments
  - ▶ EN 61000-6-3:2007 Electromagnetic compatibility (EMC) - Part 6-3: Generic



- standards – Emission standard for residential, commercial and light-industrial environments Amendments A1:2011 and AC:2012 to EN 61000-6-3
- ▶ EN 61326-1:2013 Electrical equipment for measurement, control and laboratory use - EMC requirements - Part 1: General requirements
  - ▶ EN 61326-2-3:2013 Electrical equipment for measurement, control and laboratory use - EMC requirements - Part 2-3: Particular requirements – Test configuration, operational conditions and performance criteria for transducers with integrated or remote signal conditioning
  - Low Voltage Directive 2014/35/EU
    - ▶ EN 60529:1991 Degrees of protection provided by enclosures (IP Code) Amendment AC:1993 to EN 60529
    - ▶ EN 60730-1:2011 Automatic electrical controls for household and similar use - Part 1: General requirements
  - WEEE 2012/19/EC
  - RoHs Directive 2011/65/EC

## OPERATIONAL DIAGRAMS



## WIRING AND CONNECTIONS

Wiring diagram		
RJ45 sockets (Power over Modbus)		
Pin 1	24 VDC	Supply voltage
Pin 2		
Pin 3	A	Modbus RTU communication, signal A
Pin 4		
Pin 5	/B	Modbus RTU communication, signal /B
Pin 6		
Pin 7	GND	Ground, supply voltage
Pin 8		

Terminal Block 1	
VIN	Supply voltage 24 VDC
GND	Supply voltage, ground
A	Modbus RTU communication, signal A
/B	Modbus RTU communication, signal /B

Terminal Block 2	
AO1	Analogue / modulating output 1 for temperature measurement (0–10 VDC / 0–20 mA / PWM)
GND	Ground AO1
AO2	Analogue / modulating output 2 for relative humidity measurement (0–10 VDC / 0–20 mA / PWM)
GND	Ground AO2
AO3	Analogue / modulating output 3 for TVOC measurement (0–10 VDC / 0–20 mA / PWM)
GND	Ground AO3

**ATTENTION**

*The unit needs to be supplied via the RJ45 connector or via the connection terminals. Do not connect the device via the RJ45 connector and the terminal block simultaneously!*

## MOUNTING INSTRUCTIONS IN STEPS

**ATTENTION**

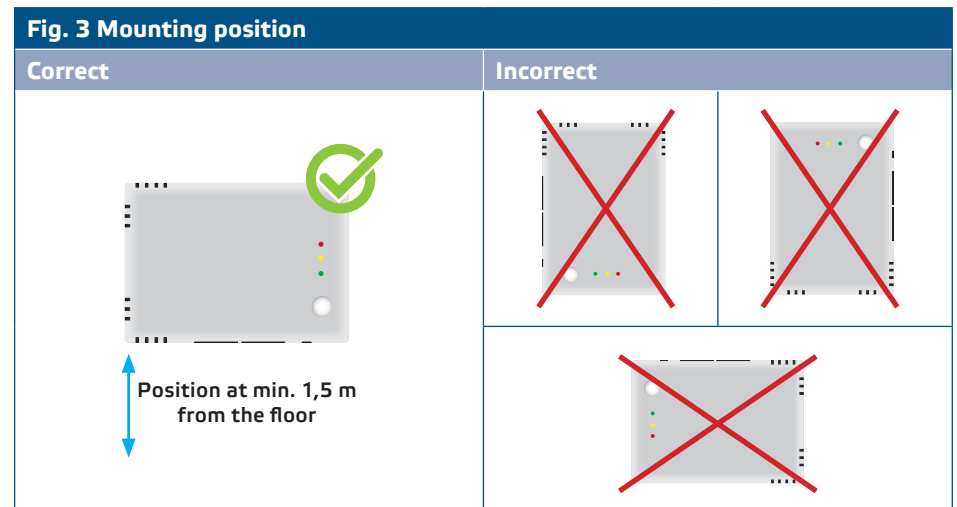
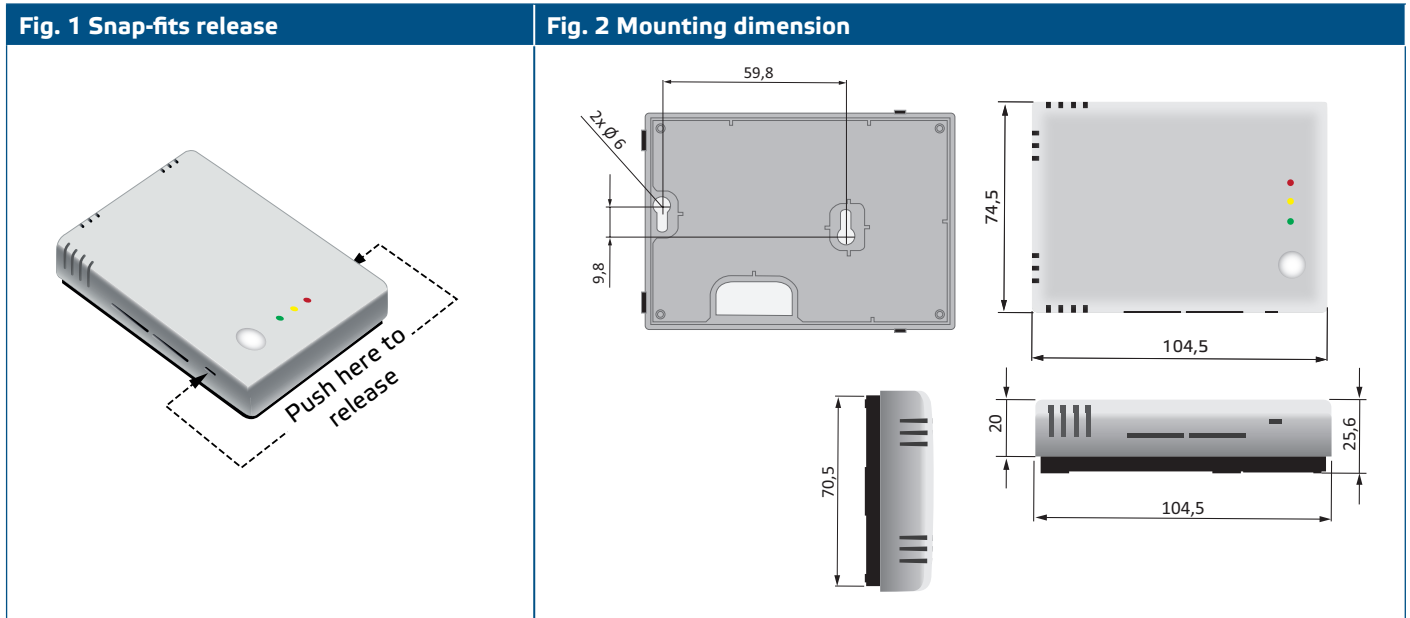
Before you start mounting the unit, read carefully **“Safety and Precautions”**. Choose a smooth surface for installation (a wall, panel and etc.).

*Mount the sensor in a well-ventilated area, where it receives adequate airflow for proper operation and hide it from direct sunlight. Make sure it can be easily accessed for service.*

**Follow these steps:**

1. Using a flat screwdriver, remove the front white cover by releasing the snap-fits on its both sides (see **Fig. 1 Snap-fits release**).
2. Insert the cables through the opening on the rear plate (see **Fig. 2 Mounting dimensions**.)

3. Using suitable fastening materials (not supplied), position the room sensor at least 1,5 m from the floor. When planning the installation, allow enough clearance for maintenance and service. Mount the sensor in a well-ventilated area. Mind the correct mounting position and unit dimensions. See **Fig. 2** and **Fig. 3**.

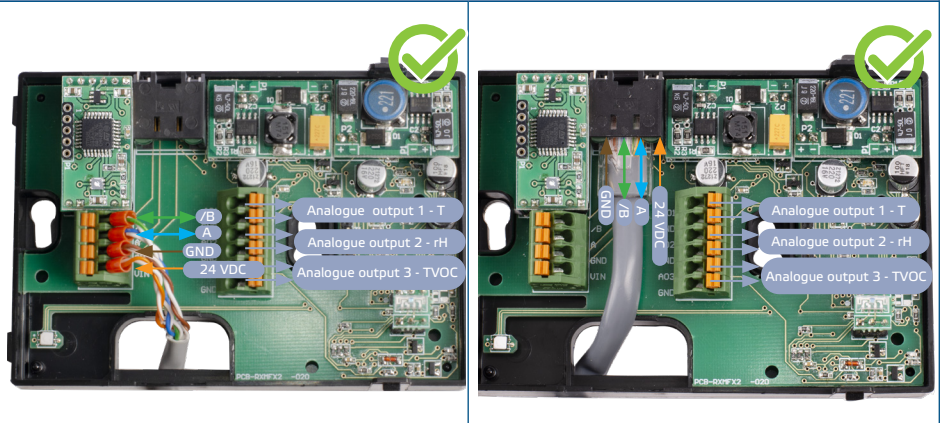


4. Do the wiring according to the wiring diagram (see **Fig. 4**).

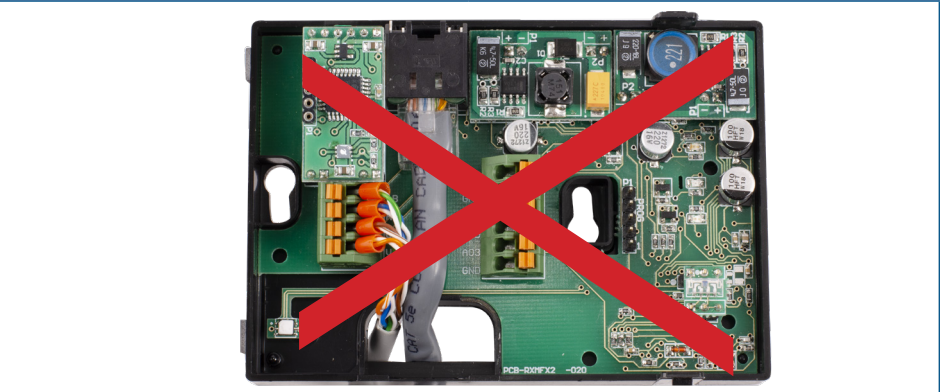


**Fig. 4 Wiring and connections**

**Correct connections**



**Wrong input connection**



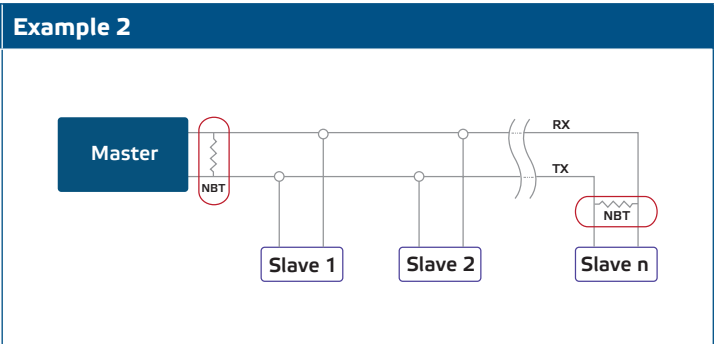
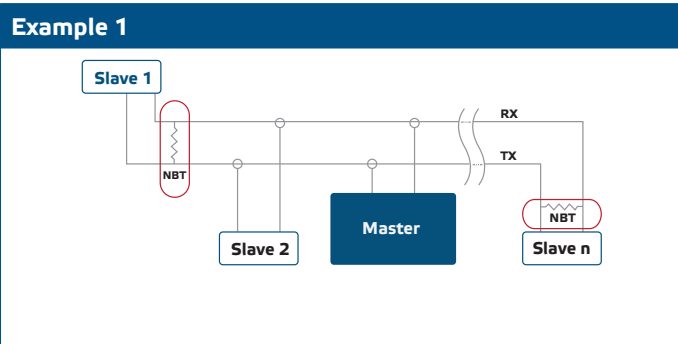
5. Put back the cover snap it in.
6. Switch on the mains supply.
7. Customise the factory settings to the desired ones via the 3SModbus software or Sensistant (if necessary). For the default factory setting refer to the product *Modbus register map*.

**NOTE**

*For the complete Modbus register data, refer to the product Modbus Register Map, which is a separate document attached to the article code on the website and contains the registers list. Products with earlier firmware versions may not be compatible with this list.*

**Optional settings**

To assure correct communication, the NBT needs to be activated in only two devices on the Modbus RTU network. If necessary, enable the NBT resistor via 3SModbus or Sensistant (*Holding register 9*).





**NOTE**

*On a Modbus RTU network, two bus terminators (NBTs) need to be activated.*

**ATTENTION**

*Do not expose to direct sunlight!*

**NOTE**

*The sensor is not designed, manufactured or intended for control or monitoring equipment in environments requiring life safety performance, in which the failure of the sensor could lead directly to death, personal injury, or severe physical or environmental damage.*

**OPERATING INSTRUCTIONS**

**NOTE**

*The compounds released from plastics may influence the sensor readings. Please allow several days for the sensor to stabilize before you obtain the accurate values.*

**NOTE**

*The warm-up time for the sensor to attain its highest accuracy and performance level once the voltage supply has been applied is 15 minutes. During the warm-up period, TVOC measurements will return 0 ppb.*

**Calibration procedure:**

All sensor elements are calibrated and tested in our factory. In the unlikely event of TVOC sensor element failure, this component can be replaced.

**Firmware update**

New functionalities and bug fixes are made available via a firmware update. In case your device does not have the latest firmware installed, it can be updated. SenteraWeb is the easiest way to update the unit firmware. In case you do not have an internet gateway available, the firmware can be updated via the 3SM boot application (part of the Sentera 3SMcenter software suite).

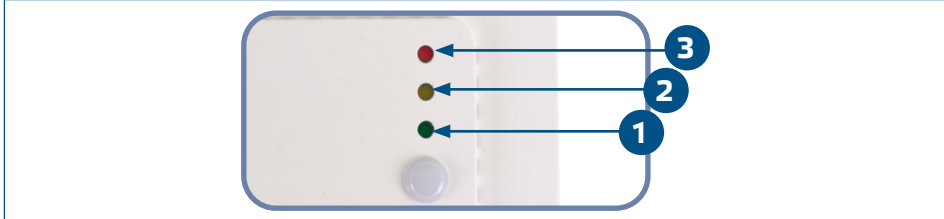
**NOTE**

*Make sure the power supply does not get interrupted during "bootload" procedure.*

**LED indications:**

1. When the green LED is on, the measured value (TVOC, temperature or relative humidity) is between the minimum and maximum alert range values (**Fig. 5 - 1**).
2. When the yellow LED is on, the measured value (TVOC, temperature or relative humidity) is in the alert range (**Fig. 5 - 2**).
3. When the red LED is on, the measured value (TVOC, temperature or relative humidity) is below the minimum measurement range value or above the maximum value. Blinking red LED indicates loss of communication with a sensor (**Fig. 5 - 3**).

**Fig. 5 LED indications**





## NOTE

*By default, the LED indication refers to TVOC measurements. This can be changed to temperature or relative humidity values via Modbus Holding Register 79 (see Table Holding registers).*



## NOTE

*LED intensity can be adjusted between 0 and 100 % with a step of 10 % according to the value set in Holding register 80.*

### Ambient light sensor

The measured light intensity in lux is available in Input Register 41. Additionally, an active and standby level can be defined in Holding registers 35 and 36. Input Register 42 indicates if the measured value is below standby level, above active level or in between both levels:

- Ambient light level < standby level: Input Register 42 indicates "Standby".
- Ambient light level > active level: Input Register 42 indicates "Active".
- Standby level < Ambient light level < Active level: Input Register 42 indicates "Low intensity".

## VERIFICATION OF INSTALLATION

---

After switching on the power supply one of the LEDs lights up according to the status of the measured variable. If this is not the case, check the connections.

## TRANSPORT AND STORAGE

---

Avoid shocks and extreme conditions; stock in original packing.

## WARRANTY AND RESTRICTIONS

---

Two years from the delivery date against defects in manufacturing. Any modifications or alterations to the product after the date of publication relieve the manufacturer of any responsibilities. The manufacturer bears no responsibility for any misprints or mistakes in this data.

## MAINTENANCE

---

In normal conditions this product is maintenance-free. If soiled, clean with a dry or damp cloth. In case of heavy pollution, clean with a non-aggressive product. In these circumstances the unit should be disconnected from the supply. Pay attention that no fluids enter the unit. Only reconnect it to the supply when it is completely dry.