

FCMFX-R | INTELLIGENT CO₂ SENSOR

Mounting and operating instructions



Table of contents

SAFETY AND PRECAUTIONS	3
PRODUCT DESCRIPTION	4
ARTICLE CODE	4
INTENDED AREA OF USE	4
TECHNICAL DATA	4
STANDARDS	4
OPERATIONAL DIAGRAMS	5
WIRING AND CONNECTIONS	6
MOUNTING INSTRUCTIONS IN STEPS	6
OPERATING INSTRUCTIONS	9
VERIFICATION OF INSTALLATION	10
TRANSPORT AND STORAGE	10
WARRANTY AND RESTRICTIONS	10
MAINTENANCE	10

SAFETY AND PRECAUTIONS



Read all the information, the datasheet, Modbus map, mounting and operating instructions and study the wiring and connection diagram before working with the product. For personal and equipment safety, and for optimum product performance, make sure you entirely understand the contents before installing, using or maintaining this product.



For safety and licensing (CE) reasons, unauthorised conversion and /or modifications of the product are inadmissible.



The product should not be exposed to abnormal conditions, such as extreme temperatures, direct sunlight or vibrations. Long-term exposure to chemical vapours in high concentration can affect the product performance. Make sure the work environment is as dry as possible; avoid condensation.



All installations shall comply with local health and safety regulations and local electrical standards and approved codes. This product can only be installed by an engineer or a technician who has expert knowledge of the product and safety precautions.



Avoid contacts with energised electrical parts. Always disconnect the power supply before connecting, servicing or repairing the product.



Always verify that you apply appropriate power supply to the product and use appropriate wire size and characteristics. Make sure that all the screws and nuts are well tightened and fuses (if any) are fitted well.



Recycling of equipment and packaging should be taken into consideration and these should be disposed of in accordance with local and national legislation / regulations.



In case there are any questions that are not answered, please contact your technical support or consult a professional.

PRODUCT DESCRIPTION

The FCMFX-R series are intelligent sensors featuring adjustable temperature, relative humidity and CO₂ ranges. The used algorithm controls a single analogue / modulating output based on the measured T, rH and CO₂ values, which can be used to directly control an EC fan, an AC fan speed controller or an actuator powered damper. All parameters are accessible via Modbus RTU.

ARTICLE CODE

Article code	Supply	I _{max}
FCMFG-R	18–34 VDC	90 mA
	15–24 VAC ±10%	180 mA
FCMFF-R	18–34 VDC	90 mA

INTENDED AREA OF USE

- Demand controlled ventilation based on temperature, relative humidity and CO₂
- Suited for residential and commercial buildings
- For indoor use only

TECHNICAL DATA

- Spring contact terminal blocks
- Analogue / modulating output type:
 - ▶ 0–10 VDC mode: R_L ≥ 50 kΩ
 - ▶ 0–20 mA mode: R_L ≤ 500 Ω
 - ▶ PWM (open-collector type) mode: PWM Frequency: 1 kHz, min, R_L ≥ 50 kΩ; PWM voltage level 3,3 or 12 VDC
- Selectable temperature range: 0–50 °C
- Selectable relative humidity range: 0–100 %
- Selectable CO₂ range: 0–2.000 ppm
- Replaceable CO₂ sensor element
- 3 LEDs with adjustable light intensity for status indication
- Accuracy: ±0,4 °C (range: 0–50 °C); ±3 % rH (range: 0–100 % rH); ±30 ppm CO₂ (range: 400–2.000 ppm), depending on the selected parameter
- Inset or surface mounting
- Enclosure:
 - ▶ internal: plastic RABS, black
 - ▶ external: ABS, white
 - ▶ cover: ASA, white
- Protection standard: IP30 (according to EN 60529)
- Typical range of use:
 - ▶ temperature: 0–50 °C
 - ▶ rel. humidity: 0–95 % rH (non-condensing)
 - ▶ CO₂: 400–2.000 ppm
- Storage temperature: -10–60 °C

STANDARDS

- Low Voltage Directive 2014/35/EC CE
 - ▶ EN 60529:1991 Degrees of protection provided by enclosures (IP Code) Amendment AC:1993 to EN 60529
 - ▶ EN 60730-1:2011 Automatic electrical controls for household and similar use -

- Part 1: General requirements
- EMC Directive 2014/30/EC:
 - ▶ EN 60730-1:2011 Automatic electrical controls for household and similar use - Part 1: General requirements
 - ▶ EN 61000-6-1:2007 Electromagnetic compatibility (EMC) - Part 6-1: Generic standards-Immunity for residential, commercial and light industrial environments
 - ▶ EN 61000-6-3:2007 Electromagnetic compatibility (EMC) - Part 6-3: Generic standards - Emission standard for residential, commercial and light-industrial environments Amendments A1:2011 and AC:2012 to EN 61000-6-3
 - ▶ EN 61326-1:2013 Electrical equipment for measurement, control and laboratory use - EMC requirements - Part 1: General requirements
 - ▶ EN 61326-2-3:2013 Electrical equipment for measurement, control and laboratory use - EMC requirements - Part 2-3: Particular requirements - Test configuration, operational conditions and performance criteria
 - WEEE 2012/19/EC
 - RoHS Directive 2011/65/EC

OPERATIONAL DIAGRAMS

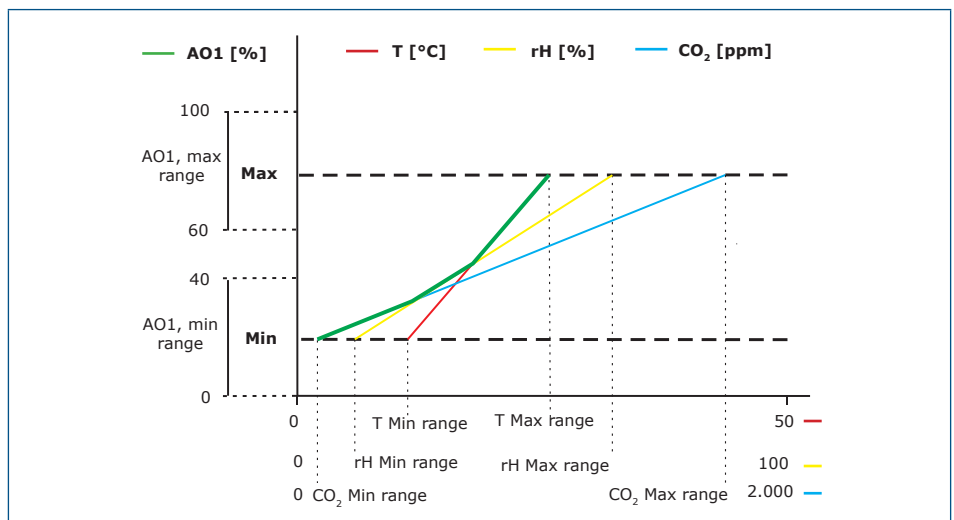

The output changes automatically depending on the highest of the T, rH or CO₂ values, i.e. the highest of the three output values controls the output. See the green line in the operational diagram above. One or multiple sensors can be deactivated. E.g. it is also possible to control the output based on the measured CO₂ level only.

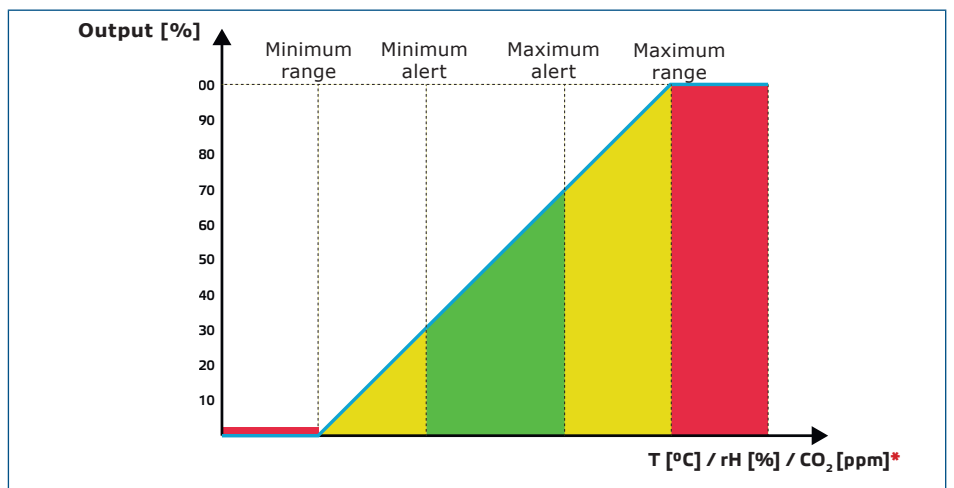

* LED indications - T, rH or CO₂ (default)

WIRING AND CONNECTIONS

Article type	FCMFF-R	FCMFG-R	
V+	18–34 VDC	18–34 VDC	15–24 VAC ±10%
V-	Ground	Common ground	AC ~
A	Modbus RTU (RS485), signal A		
/B	Modbus RTU (RS485), signal /B		
AO	Analogue / modulating output (0–10 VDC / 0–20 mA / PWM)		
GND	Ground AO	Common ground	
Connections	Spring contact terminal block, cable cross section: 2,5 mm ² ; pitch 5 mm; shielded cable		

ATTENTION

The -F version of the product is not suited for 3-wire connection. It has separate grounds for power supply and analogue output. Connecting both grounds together might result in incorrect measurements. Minimum 4 wires are required to connect -F type sensors.

The -G version is intended for 3-wire connection and features a 'common ground'. This means that the ground of the analogue output is internally connected with the ground of the power supply. For this reason, -G and -F types cannot be used together on the same network. Never connect the common ground of -G type articles to other devices powered by a DC voltage. Doing so might cause permanent damage to the connected devices.

MOUNTING INSTRUCTIONS IN STEPS

Before you start mounting the unit, read carefully "**Safety and Precautions**". Choose a smooth surface for installation (a wall, panel, etc.). Then proceed with the following steps:

ATTENTION

When planning the installation, allow enough clearance for maintenance and service. Mount the sensor in a well-ventilated area.

Inset mounting

1. Disconnect the supply voltage.
2. Remove the cover of the enclosure and take the controller out of the housing, so

that it can be easily connected.

- Do the wiring according to the wiring diagram (see Fig. 1).

Fig. 1 Wiring and connections

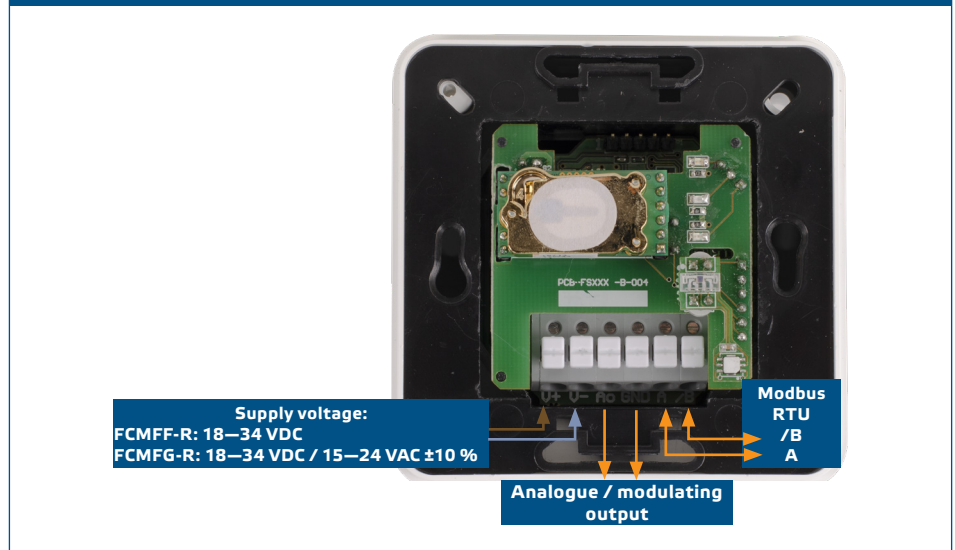

- Mount the internal enclosure into the wall using appropriate connecting elements (not included in the set). Mind the correct position and mounting dimensions shown in Fig. 2 and Fig. 3.

Fig. 2 Mounting dimensions - inset mounting

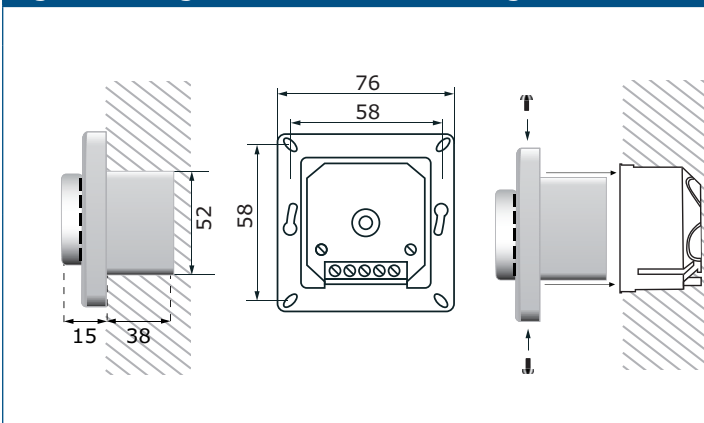
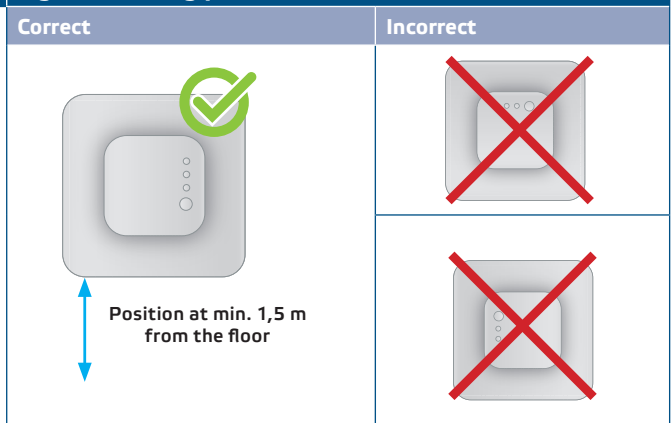

Fig. 3 Mounting position



- Put back the frame cover of the enclosure and secure it with the screws.
- Switch on the power supply.
- Customise the factory settings to the desired ones via the **3SModbus** software or the Sensistant configurator. For the default factory settings, see the **Modbus register map** of the product.

For surface mounting

- Disconnect the power supply.
- Remove the frame cover of the enclosure.
- Take out the internal enclosure.
- Mount the external enclosure onto the wall using the dowels and screws included in the set. Mind the correct position and mounting dimensions shown in Fig. 4 and Fig. 5.

5. Insert the connecting cables through the grommets of the unit.

Fig. 4 Mounting dimensions - surface mounting

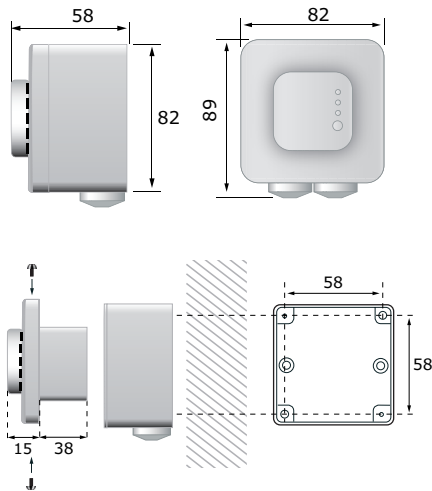
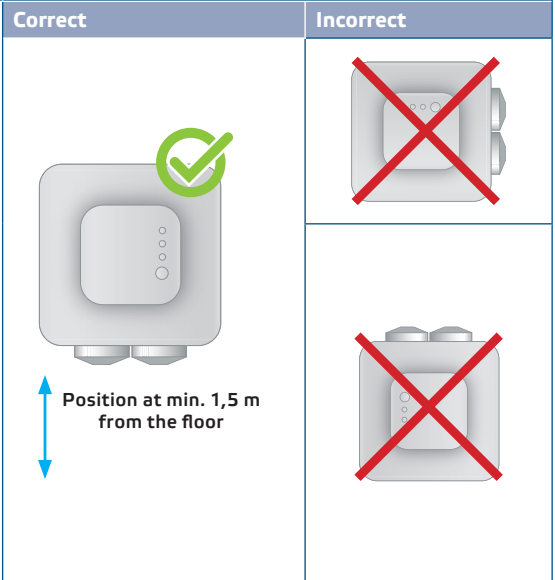

Fig. 5 Mounting position



- Do the wiring according to the wiring diagram (see Fig. 1) using the information from section "Wiring and connections".
- Put the internal enclosure into the external one and fix it using the delivered screws and washers (Fig. 4).
- Put back the frame cover of the enclosure and secure it with the screws.
- Switch on the power supply.
- Customise the factory settings to the desired ones via the 3SModbus software or the Sensistant configurator. For the default factory settings, see the **Modbus register map** of the product.

Optional settings

To assure correct communication, the NBT needs to be activated in only two devices on the Modbus RTU network. If necessary, enable the NBT resistor via 3SModbus or Sensistant (*Holding register 9*).

Example 1

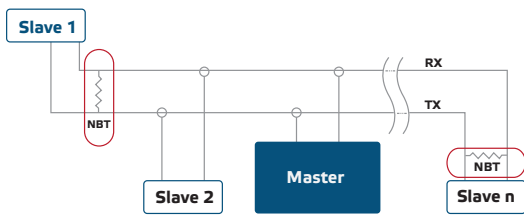

Example 2

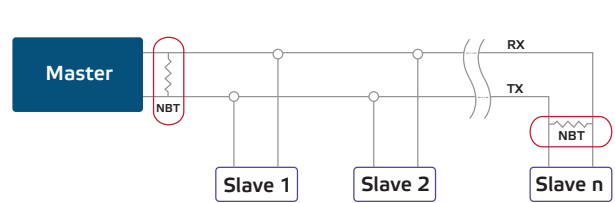

NOTE

On a Modbus RTU network, two bus terminators (NBTs) need to be activated.



NOTE

For the complete Modbus register data, see the Modbus Register Map of the product. This is a separate document linked to the article code on the website containing the list of registers. Products with earlier firmware versions may not be compatible with this list.



NOTE

Mount the unit so that the terminal block and connections are at the bottom.

ATTENTION

Do not expose to direct sunlight!

OPERATING INSTRUCTIONS

ATTENTION

The unit is supplied with electrical energy at voltages high enough to inflict personal injury or threat to health.

Calibration procedure:

Sensor calibration is not necessary. All sensor elements are calibrated and tested in our factory. In the unlikely event of CO₂ sensor element failure, this component can be replaced.

Firmware update

New functionalities and bug fixes are made available via a firmware update. In case your device does not have the latest firmware installed, it can be updated. SenteraWeb is the easiest way to update the firmware of the unit. In case you do not have an internet gateway available, the firmware can be updated via the 3SM boot application (part of the Sentera 3SMcenter software suite).

NOTE

Make sure the power supply does not get interrupted during "bootload" procedure, otherwise you risk losing unsaved data.

LED indications

1. When the green LED is on, the measured value (temperature, relative humidity or CO₂) is between the minimum and maximum alert range values (**Fig. 6**).
2. When the yellow LED is on, the measured value (temperature, relative humidity or CO₂) is in the alert range (**Fig. 6**).
The yellow LED is blinking when the Modbus communication has stopped and HR8 is activated (Modbus timeout > 0 seconds)
3. When the red LED is on, the measured value (temperature, relative humidity or CO₂) is below the minimum measurement range value or above the maximum value. Blinking red LED indicates loss of communication with a sensor (**Fig. 6**).

Fig. 6 LED indications

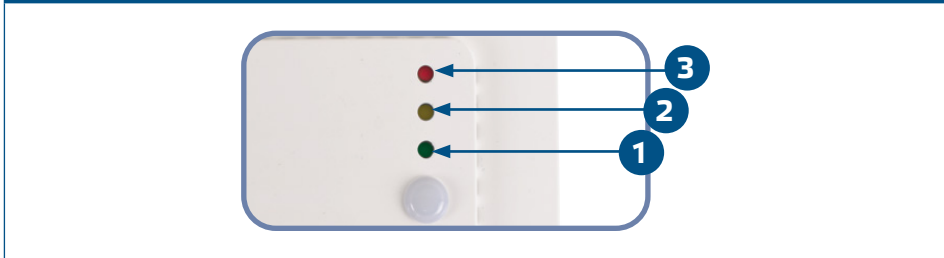

NOTE

When the sensor is in bootloader mode, the green and yellow LEDs flash alternately. During the firmware download, the red LED is flashing additionally.

NOTE

By default, the LED indication refers to CO₂ measurements. This can be changed to temperature or relative humidity values via Modbus Holding Register 79 (see Table Holding registers).



NOTE

The intensity of the LEDs can be adjusted between 0 and 100 % with a step of 10 % according to the value set in Holding register 80. Writing "0" in Holding register 80 turns OFF all LEDs.

Ambient light sensor

The measured light intensity in lux is available in Input Register 41. Additionally, an active and standby level can be defined in Holding registers 35 and 36. Input Register 42 indicates if the measured value is below standby level, above active level or in between both levels:

- Ambient light level < standby level: Input Register 42 indicates "Standby".
- Ambient light level > active level: Input Register 42 indicates "Active".
- Standby level < Ambient light level < Active level: Input Register 42 indicates "Low intensity".

VERIFICATION OF INSTALLATION

After switching on the power supply one of the LEDs lights up according to the status of the measured variable. If this is not the case, check the connections.

TRANSPORT AND STORAGE

Avoid shocks and extreme conditions; stock in original packing.

WARRANTY AND RESTRICTIONS

Two years from the delivery date against defects in manufacturing. Any modifications or alterations to the product after the date of publication relieve the manufacturer of any responsibilities. The manufacturer bears no responsibility for any misprints or mistakes in this data.

MAINTENANCE

In normal conditions this product is maintenance-free. If soiled, clean with a dry or damp cloth. In case of heavy pollution, clean with a non-aggressive product. In these circumstances the unit should be disconnected from the supply. Pay attention that no fluids enter the unit. Only reconnect it to the supply when it is completely dry.