

AH2C1-6 | ELECTRONIC HEATING CONTROLLER

Mounting and operating instructions



Table of contents

SAFETY AND PRECAUTIONS	3
PRODUCT DESCRIPTION	4
ARTICLE CODES	4
INTENDED AREA OF USE	4
TECHNICAL DATA	4
STANDARDS	5
WIRING AND CONNECTIONS	5
OPERATIONAL DIAGRAM	5
MOUNTING INSTRUCTIONS IN STEPS	6
OPERATING INSTRUCTIONS	6
VERIFICATION OF INSTALLATION	10
TRANSPORT AND STORAGE	10
WARRANTY AND RESTRICTIONS	10
MAINTENANCE	10

SAFETY AND PRECAUTIONS



Read all the information, the datasheet, mounting and operating instructions and study the wiring and connection diagram before working with the product. For personal and equipment safety, and for optimum product performance, make sure you entirely understand the contents before installing, using, or maintaining this product.



For safety and licensing (CE) reasons, unauthorised conversion and /or modifications of the product are inadmissible.



The product should not be exposed to abnormal conditions, such as: extreme temperatures, direct sunlight or vibrations. Long-term exposure to chemical vapours in high concentration can affect the product performance. Make sure the work environment is as dry as possible; avoid condensation.



All installations shall comply with local health and safety regulations and local electrical standards and approved codes. This product can only be installed by an engineer or a technician who has expert knowledge of the product and safety precautions.



Avoid contacts with energised electrical parts. Always disconnect the power supply before connecting, servicing or repairing the product.



Always verify that you apply appropriate power supply to the product and use appropriate wire size and characteristics. Make sure that all the screws and nuts are well tightened and fuses (if any) are fitted well.



Recycling of equipment and packaging should be taken into consideration and these should be disposed of in accordance with local and national legislation / regulations.



In case there are any questions that are not answered, please contact our technical support or consult a professional.

PRODUCT DESCRIPTION

AH2C1-6 are electric heating controllers for single-phase or two-phase electric heating. They utilise time-proportional control: the ratio between on-time and off-time alters in order to fit the heating requirements. The current is triac-switched, which minimises wear and tear, while enhanced control accuracy reduces energy costs.

ARTICLE CODES

Article code	Device type	Potentiometers	Temperature probe
AH2C1-6	Master / Slave	yes	no (external PT500 to be used)
AH2C1-6-500	Master / Slave	yes	built-in PT500

INTENDED AREA OF USE

- Control of heating systems
- For indoor use only

TECHNICAL DATA

- Master or Slave mode
- Modbus RTU communication
- Supply voltage:
 - ▶ single phase: 230 VAC $\pm 10\%$ / 50–60 Hz
 - ▶ two phase: 400 VAC $\pm 10\%$ / 50–60 Hz
- Regulated output:
 - ▶ single phase: max. 3,2 kW (230 VAC)
 - ▶ two phase: 6 kW (400 VAC)
- Temperature measurement range: -30–70 °C
- Analogue output: 0–10 VDC / 0–20 mA
- Analogue input: 0–10 VDC / 0–20 mA
- Input for external potentiometer 10 K Ω
- Digital input 1: NO contact for external timer for day / night mode selection
- Digital input 2: NC contact for remote on/off switching
- Integrated potentiometers for day and night temperature setpoint selection
- Protection standard: IP54 (according to EN 60529)
- Operating ambient conditions:
 - ▶ temperature: -20–40 °C
 - ▶ rel. humidity: 5–85 % rH (non-condensing)

STANDARDS

- CE
 ■ Low Voltage Directive 2014/35/EU
 - ▶ EN 60730-1:2011 Automatic electrical controls for household and similar use - Part 1: General requirements
 - ▶ EN 60730-2-9:2010 Automatic electrical controls for household and similar use - Part 2-9: Particular requirements for temperature sensing controls
- EMC directive 2014/30/EU:
 - ▶ EN 61000-6-1:2007 Electromagnetic compatibility (EMC) - Part 6-1: Generic standards - Immunity for residential, commercial and light industrial environments
 - ▶ EN 61000-6-3:2007 Electromagnetic compatibility (EMC) - Part 6-3: Generic standards - Emission standard for residential, commercial and light-industrial environments Amendments A1:2011 and AC:2012 to EN 61000-6-3
- RoHs Directive 2011/65/EU

WIRING AND CONNECTIONS

Connections	
L	Power supply (230 VAC or 400 VAC)
N	Neutral for 230 VAC or Line for 400 VAC
PE	Protective earth
N	Load output for heater
H	
Ao1	Analogue output for connecting a slave device (if applicable)
GND	Ground for analogue input and output
Ai1	Analogue input - temperature setpoint - cannot be used in master mode
+, -	Connection for external potentiometer (e.g. MTP-X10K-NA) - cannot be used in slave mode
Ext Sp	
NO	Input - normally open contact to switch from day to night setpoint - <i>cannot be used in slave mode</i>
GND	GND for NO and NC input contacts
NC	Input - normally closed contact for remote ON / OFF switching
GND	Modbus RTU (RS485), ground
T1	Connection terminals for an external temperature probe in AH2C1-6 (<i>not available in AH2C1-6-500, where the probe is integrated</i>)

OPERATIONAL DIAGRAM

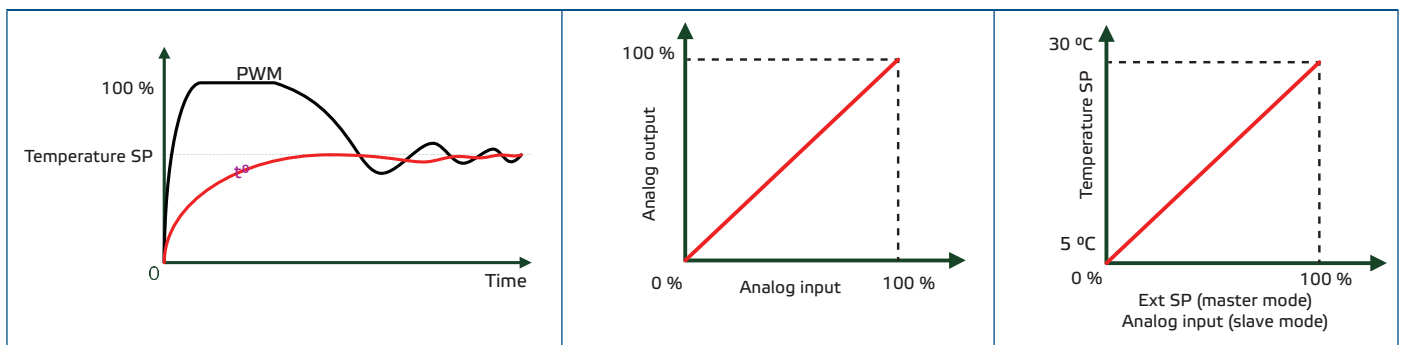

MOUNTING INSTRUCTIONS IN STEPS

Before you start mounting AH2C1-6, read carefully **“Safety and Precautions”**. Choose a smooth surface for installation (e.g. a wall, a panel, etc.).

ATTENTION

Before mounting the device switch off the mains supply!

Follow these steps:

1. Unscrew the cover and open the controller. Mind the ribbon that connects the two printed circuit boards.
2. Insert the high voltage cables through the grommets and connect them according to the wiring diagram.
3. Fix the unit onto the wall or panel using the provided screws and dowels. Mind the correct mounting position and unit mounting dimensions (see **Fig. 1 Mounting dimensions** and **Fig. 2 Mounting position**).

Fig. 1 Mounting dimensions

Article code	A	B	C	D	E	F
AH2C1-6	202 mm	115 mm	68 mm	102 mm	140 mm	∅ 4,60 mm

Fig. 2 Mounting position

Correct	Incorrect

4. Insert the low voltage cables through the cable glands and connect them to the relevant terminal (refer to section **Operating Instructions** below for further details).
5. Put back the cover and secure it with the screws.
6. Switch on the mains supply.

OPERATING INSTRUCTIONS

AH2C1 can operate both as a Master and a Slave device. Master and Slave modes are selected via Modbus holding register 13 (see Table Holding Registers below) or, in case you do not intend to use Modbus, via the DIP switches (see **Fig. 5** below). Depending on the selected mode and the intended use, the controller needs to be connected to the external devices.

Master mode - basic wiring (Fig. 3)

1. Connect the mains supply to L, N and Pe.
2. Connect the heater to the output terminal block - terminals N and H.
3. If your device does not have the integrated temperature probe (AH2C1-6), connect the external probe to the T1 terminals. If your device has the integrated temperature probe (AH2C1-6-500), it is ready to use.
4. Your device is now ready to control your electric heater using the integrated potentiometers for setpoint selection. However, if you intend to use the additional control options provided by the device, proceed to connecting the external equipment as specified in *Additional Control Options*.

Additional control options in Master Mode (optional)

1. **Remote ON / OFF** - terminals NC and GND. You can connect an external switch to turn the controller on and off from a distance. When the connection between the NC and GND terminals is interrupted, the controller stops and the output is set to zero; therefore the AH2C1 features a factory installed bridge between these terminals. Remote ON / OFF can only be disabled via Modbus (see Modbus Tables below).
2. **External timer / clock** - terminals NO and GND. Apart from the two day and night integrated potentiometers for setpoint selection, AH2C1 features an option for connecting an external timer or clock for switching between the day and night potentiometers (disabling one and enabling the other).
3. **External potentiometer** - terminals Ext Sp, + and -. Apart from the two day and night integrated potentiometers for setpoint selection, AH2C1 features an option for connecting an external potentiometer device for remote setpoint selection (5–30 °C) in case AH2C1 is mounted in one room and you need to control it from another. To use this functionality, you have to enable it via the DIP switch, which has to be set in Ext. SP position (see **Fig. 5 DIP switches** below).
4. **Analogue output** - terminals Ai1 and GND. The analogue output repeats the heater PWM output i.e. 70 % PWM output is translated to 7 VDC analogue output signal, 80 % PWM is translated to 8 VDC analogue output signal, etc. It can be used to control a fan or slave device such AH2A1 or AH2C1 in slave mode to increase the power output. You can switch between 0–10 VDC or 0–20 mA via the DIP switch 4 (see **Fig. 5 DIP switches**).

Fig. 3 Master mode example

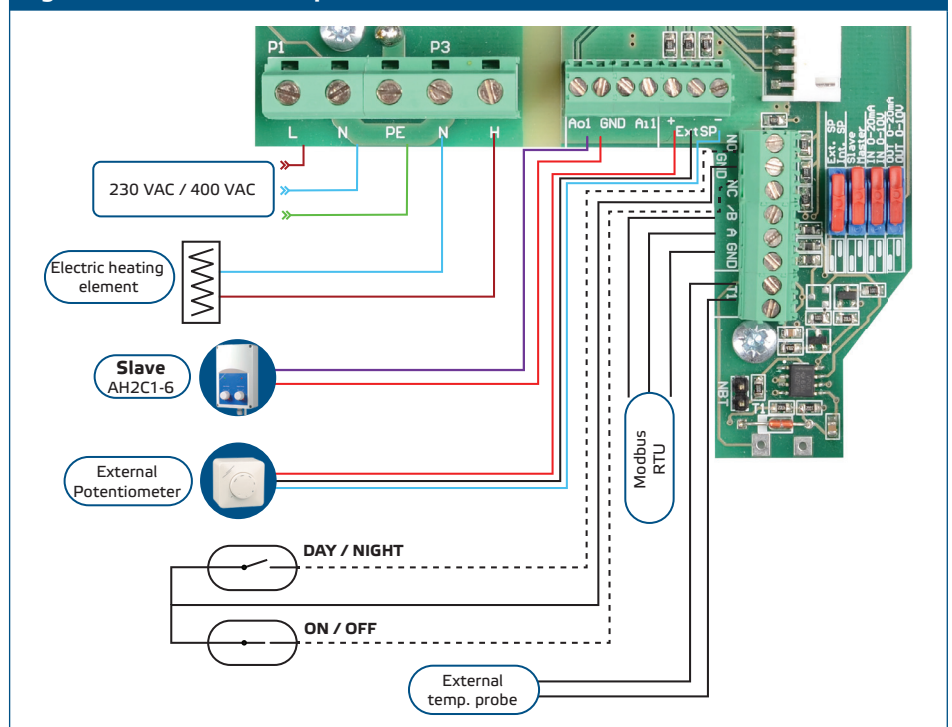

Slave mode - basic wiring (Fig. 4)

1. AH2C1 controllers can be used as a Slave device when slave mode is selected via the Ext. SP / Int. SP DIP switch or, if you use Modbus RTU communication, Modbus Holding Register 13. In this mode the temperature probe is not necessary for AH2C1-6 or automatically made redundant for AH2C1-6-500.
2. Connect the mains supply to L, N and Pe .
3. Connect the heater to the output terminal block - terminals N and H .

Additional options in Slave Mode (optional)



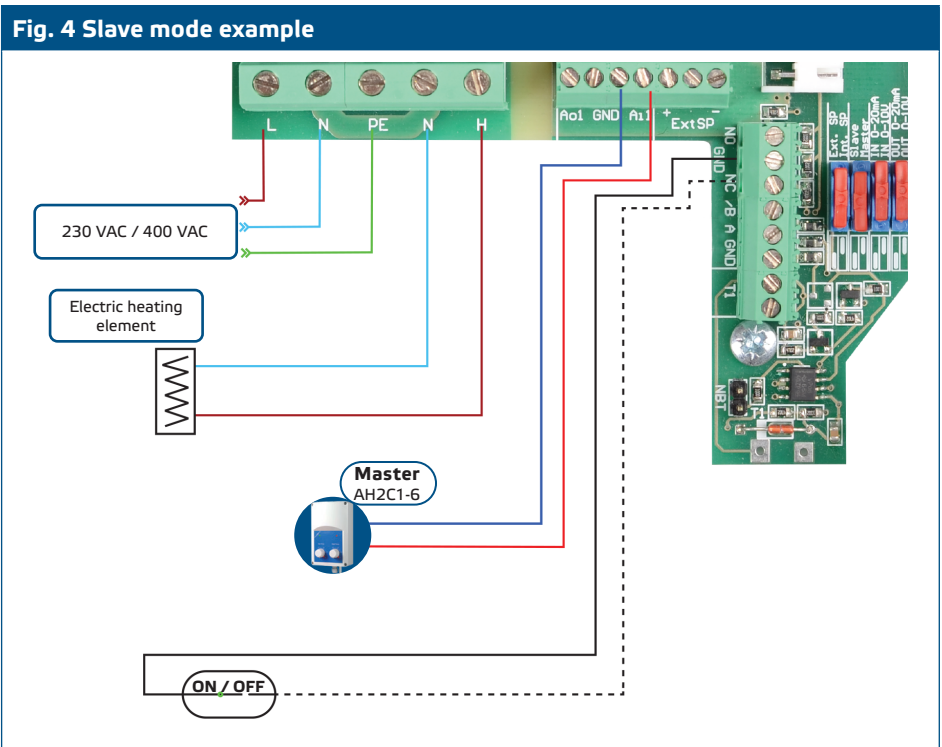



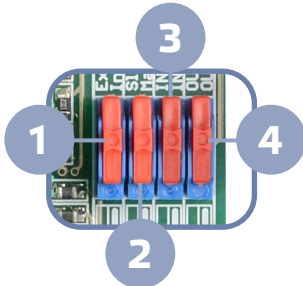

1. **Remote ON / OFF** - terminals NC and GND. You can connect an external switch to turn the controller on and off from a distance. When the connection between the NC and GND terminals is interrupted, the controller stops and the output is set to zero; therefore the AH2C1 features a factory installed bridge between these terminals. Remote ON / OFF can only be disabled via Modbus (see **Modbus Tables** below).
2. **Analogue input** - terminals Ai1 and GND. The heater PWM output follows the analogue input signal. You can switch between 0–10 VDC or 0–20 mA via DIP switch 3 (see **Fig. 5 DIP switches**).



AH2C1 features four DIP switches for manual parameter selection, however, if Modbus protocol is used, it takes priority over the DIP switch settings and overrides the latter. See **Fig. 5** below for further details on the DIP switch settings and the **Modbus Register Maps** for the Modbus settings.

Fig. 5 DIP switches



1 - Setpoint*		External (external potentiometer is used)
		Internal (the integrated potentiometers are used)
2 - Mode		Slave (expansion unit)*
		Master
3 - Input type		0–20 mA
		0–10 VDC
4 - Output type		0–20 mA
		0–10 VDC

**In case DIP switch 2 is set to 'Slave', DIP switch 1 has no function anymore.*

Modbus communication

Modbus communication can be used to control AH2C1 devices remotely or from a Master controller i. e. a computer with Sentera's free 3SModbus software. When Modbus mode is selected (via holding register 7), the controller does not follow the potentiometers and the day and night set points are selected via Modbus holding registers 11 and 12 instead.

The Ext. SP / Int. SP and slave and master switches are disabled and the modes are selected by holding registers 13 and 14. The remote on/off functionality can be disabled by holding register 18. The output PWM period can be controlled by holding register 15.

Optional settings

The Network Bus Terminator (NBT) is used to set the device as an end device and by default the NBT is disconnected. It is put manually onto the pins to be connected (see **Fig. 6**). To assure correct communication, the NBT jumper needs to be activated in only two devices on the Modbus RTU network (see **Example 1** and **Example 2**).

Fig. 6 NBT jumper

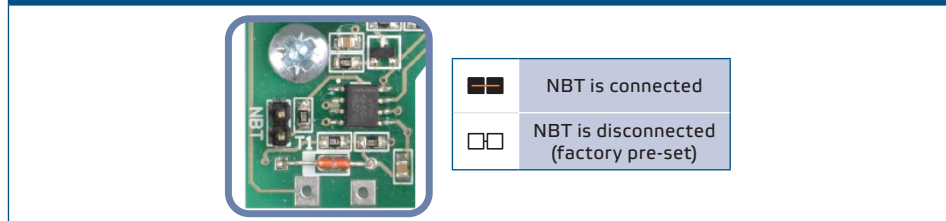

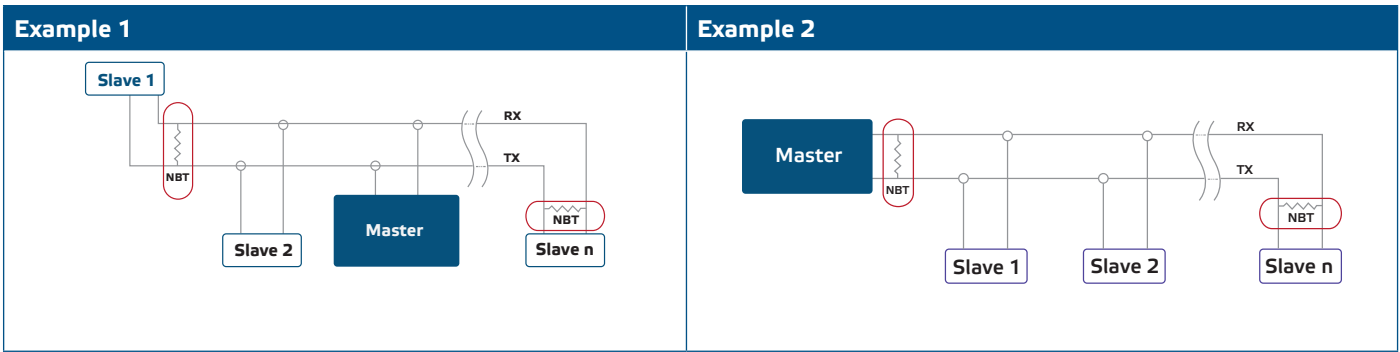

ATTENTION

On a Modbus RTU network, two bus terminators (NBTs) need to be activated

VERIFICATION OF INSTALLATION

ATTENTION

Use only tools and equipment with non-conducting handles when working on electrical devices.

1. Switch on the mains supply.
2. Turn the DAY potentiometer to maximum temperature (30 °C).
3. The red and green LEDs should be on.
4. Turn the DAY potentiometer to minimum temperature (5 °C).
5. The red LED should be on to indicate that the unit is supplied. The green LED should be off.

After the initial start period as described above, the red LED is on to indicate that the unit is supplied. The green LED indicates that the output is active. If this is not the case, check the connections.

TRANSPORT AND STORAGE

Avoid shocks and extreme conditions; stock in original packing.

WARRANTY AND RESTRICTIONS

Two years from the delivery date against defects in manufacturing. Any modifications or alterations to the product relieve the manufacturer of any responsibilities. The manufacturer bears no responsibility for any misprints or mistakes in this data.

MAINTENANCE

In normal conditions this product is maintenance-free. If soiled, clean with a dry or damp cloth. In case of heavy pollution, clean with a non-aggressive product. In these circumstances the unit should be disconnected from the supply. Pay attention that no fluids enter the unit. Only reconnect it to the supply when it is completely dry.