



# SER-1

## 230 VAC transformer controller with smoke evacuation button

The SER-1 series of transformer fan speed controllers regulate the rotational speed of single-phase voltage controllable motors by varying the output voltage. They are equipped with an auto-transformer and control the speed manually in five steps. The technology used provides a regulated output voltage with a perfect sinusoidal shape. The controllers feature an emergency button for smoke extraction.

### Key features

- Emergency button (red) to switch the fan to maximum speed (for smoke extraction)
- 5-step rotary switch for manual control plus off-position
- LED status indication
- Several voltage ranges
- Input to connect an additional emergency push button for remote control







### Technical specifications

Supply voltage	230 VAC / 50–60 Hz	
Maximum load	depends on the version	
Unregulated output	230 VAC / 2 A	
Enclosure	plastic (R-ABS, UL94-V0, grey RAL 7035)	
Protection standard	IP54 (according to EN 60529)	
Ambient conditions	Temperature	-20–35 °C
	Rel. humidity	5–95 % rH (non-condensing)

### Article codes

Article code	Rated max. current, [A]	Fuse (5*20 mm), [A]
SER-1-35L22	3,5	F: T-5,0 A-H
SER-1-50L22	5,0	F: T-8,0 A-H
SER-1-75L22	7,5	F: T-12,5 A-H

### Voltage

Knob position	0	-	1	2	3	4	5
Wires		-					
Regulated output [VAC]							
Voltages**	0	190*	80	110	140	170	230
Unregulated output [VAC]							
L1	0	230*	230	230	230	230*	230

\* Available but not connected.

\*\* When more than 5 output voltages are available, it is possible to adjust the 5 steps by changing the internal wiring.

### Standards

- Low Voltage Directive 2014/35/EC
- EMC Directive 2014/30/EC: EN 61326
- WEEE Directive 2012/19/EC
- RoHS Directive 2011/65/EC



### Area of use

- Fan speed control of voltage controllable motors (pumps and fans) in ventilation systems
- For indoor use only

### Wiring and connections

L	Power supply, line (230 VAC / 50–60 Hz)
N	Power supply, neutral
	Unregulated output, neutral
L1	Unregulated output, line
N	Regulated output to motor, neutral
U	Regulated output to motor, line
RB	Input - normally open contact for external remote button to switch the motor to maximum speed (smoke evacuation)
RB	
Pe	Earth terminal

# SER-1

230 VAC transformer controller with smoke evacuation button



## Legend

SER-1-35L22

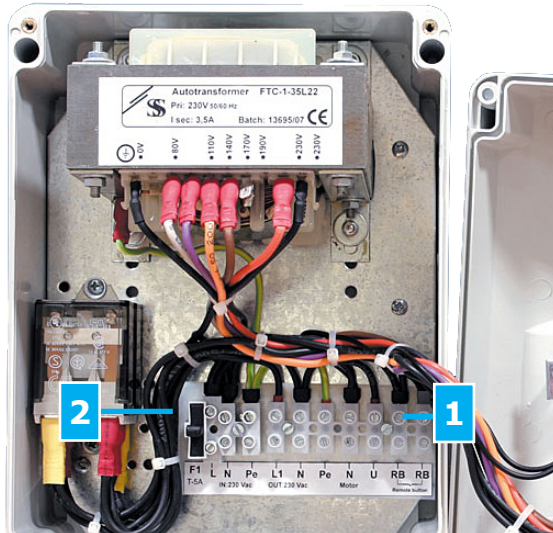

1 - Terminal block

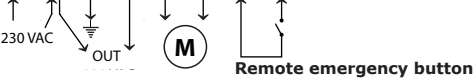

2 - Fuse

## Operational diagram

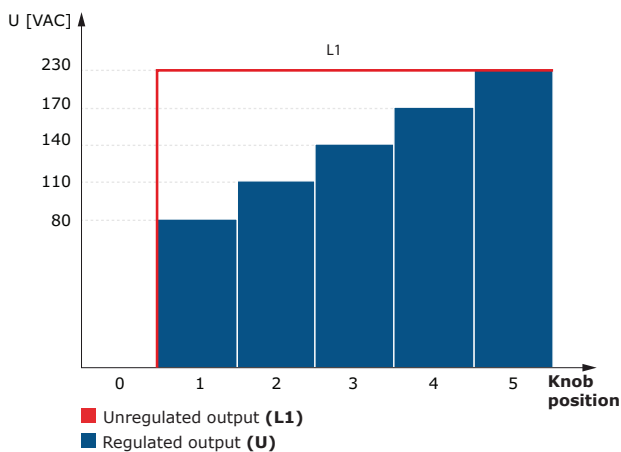

## Fixing and dimensions

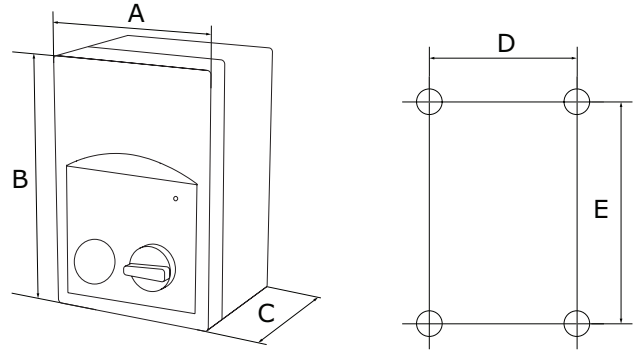

Article code	A [mm]	B [mm]	C [mm]	D [mm]	E [mm]	Enclosure
SER-1-35L22	170	255	140	155	194	plastic (R-ABS, UL94-V0, grey RAL 7035)
SER-1-50L22	170	255	140	155	194	
SER-1-75L22	200	305	155	183	236	

## Packaging

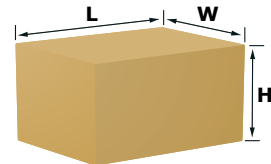

Article code	Packaging	Length [mm]	Width [mm]	Height [mm]	Net weight [kg]	Gross weight [kg]
SER-1-35L22	Unit (1 pc.)	262	180	160	5,00	5,20
SER-1-50L22	Unit (1 pc.)	262	180	160	5,80	6,00
SER-1-75L22	Unit (1 pc.)	320	210	160	8,50	8,90