



# RTVS8

## 115–230 VAC transformer fan speed controller with Modbus RTU

The RTVS8 series of transformer fan speed controllers are intended for regulating the speed of single-phase voltage controllable motors (115–230 VAC / 50–60 Hz) in five steps by varying the output voltage. They are equipped with auto-transformer(s) and feature Modbus RTU communication and TK monitoring for thermal motor protection. The unit can be controlled both in automatic mode or in manual mode. In manual mode, the unit functions as a 5-step controller. In automatic mode, the unit can be connected to a Sentera device allowing the unit to be used for demand-based ventilation.

### Key features

- Controlled via Modbus RTU communication
- TK monitoring function for thermal motor protection
- Automatic and manual control mode
- Autotransformer with voltage taps (0 / 80 / 110 / 140 / 170 / 190 / 230 VAC for 230 VAC supply and 0 / 40 / 55 / 70 / 85 / 95 / 115 VAC for 115 supply)
- Automatic mode: from low to high or from high to low speed
- Selectable output update interval from 5 seconds to 10 minutes
- LED status indication
- Controlled by analogue signal via DADCM
- Compatible with Sentera HVAC sensors and potentiometers with Modbus RTU communication for demand based ventilation in automatic mode

### Technical specifications

Supply voltage	115 or 230 VAC / 50–60 Hz	
Operating modes	Automatic	Fan speed based on input from external Sentera device connected to the RJ45 Master connector
	Manual	Fan speed based on user input via Modbus Holding Register 12
Relay output	115 VAC / 16 A (resistive)	
Enclosure	plastic (R-ABS, UL94-V0, grey RAL 7035)	
Protection standard	IP54 (according to EN 60529)	
Ambient conditions	Temperature	-10–35 °C
	Rel. humidity	5–85 % rH (non-condensing)

### Article codes

Article code	Supply voltage 115–230 VAC, I <sub>max</sub> [A]	Fuse (5*20 mm) [A]
RTVS8-15L22	1,5	T-2,5 A-H
RTVS8-25L22	2,5	T-4 A-H
RTVS8-35L22	3,5	T-5 A-H
RTVS8-50L22	5	T-8 A-H
RTVS8-75L22	7,5	T-10 A-H

### Voltage

Steps	0	—	1	2	3	4	5
Wires							
Regulated output [230 VAC]							
Voltages**	0	80*	110	140	170	190	230
Regulated output [115 VAC]							
Voltages**	0	40*	55	70	85	95	115

\* Available but not connected  
 \*\* Because more than 5 output voltages are available, it is possible to adjust the 5 steps by changing the internal wiring

### Area of use

- Fan speed control of voltage controllable motors (pumps and fans) in ventilation systems
- For indoor use only
- Demand based ventilation in greenhouses, sheds and stables
- Ventilation based on temperature, relative humidity, carbon dioxide, air quality (TVOC), carbon monoxide or nitrogen dioxide. Selection can be made via Modbus Holding register 18



### Operational diagram

115 VAC / 50–60 Hz power supply

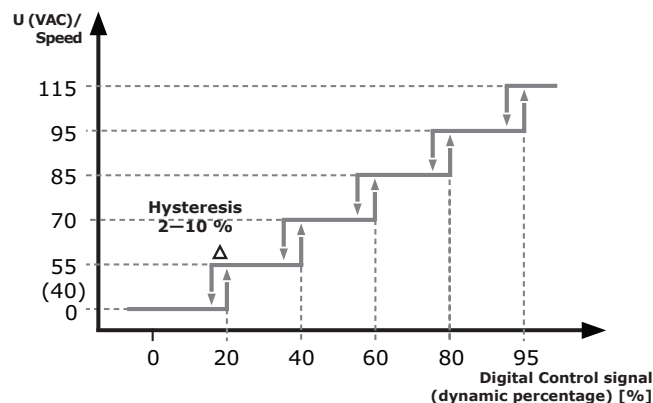

230 VAC / 50–60 Hz power supply

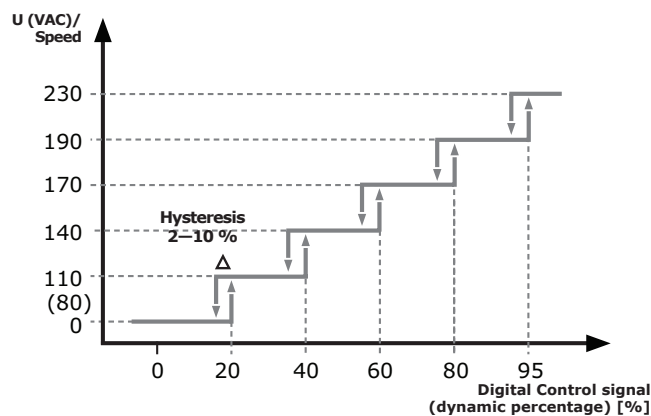

## RTVS8

115—230 VAC transformer fan speed controller with Modbus RTU



### Legend

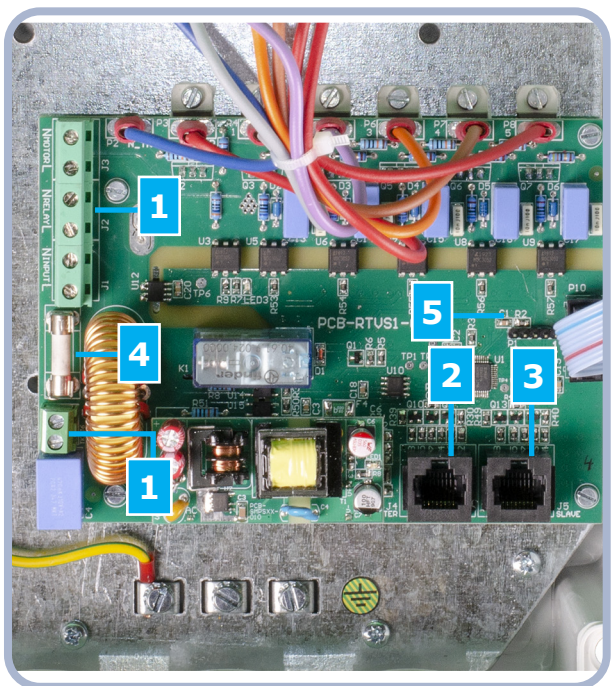

### Indications

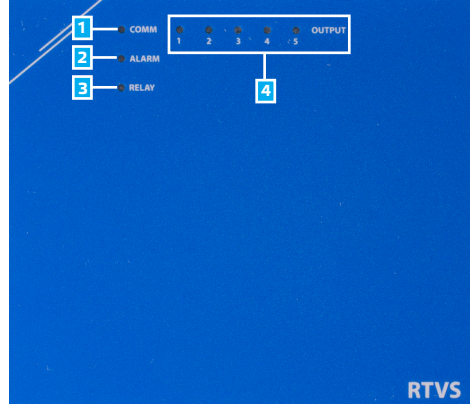

LED	Status	Meaning			
1 - Communication LED	Continuous	Device powered; no Modbus RTU communication			
	Blinking	Active Modbus RTU communication			
2 - Alarm LED	Continuous	High priority problem: ADC error, EEPROM error, Frequency error, TK active, Overheating, Overcurrent, Overload, Sensor fault			
	Blinking	<table border="1"> <tr> <td>Once every 2,5 s</td> <td>No Modbus communication with article</td> </tr> <tr> <td>Twice every 2,5 s</td> <td>No Modbus communication with connected Sentera device (sensor or digital potentiometer)</td> </tr> </table>	Once every 2,5 s	No Modbus communication with article	Twice every 2,5 s
Once every 2,5 s	No Modbus communication with article				
Twice every 2,5 s	No Modbus communication with connected Sentera device (sensor or digital potentiometer)				
3 - Relay LED	On	Unregulated output = 115 VAC, respectively 230 VAC			
	Off	Unregulated output = 0 VAC			
4 - Output LEDs	On	Indication of currently active step			

1 - Terminal block

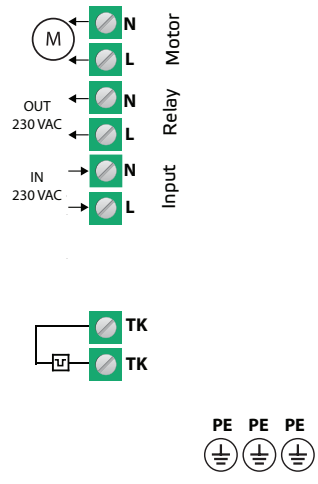

2 - RJ45 master socket  
To connect Sentera slave devices\* for automatic control. (In case no device is connected, RTVS8 can be manually controlled via Modbus holding register 12)

3 - RJ45 slave socket  
To connect a computer with 3SModbus software, Sentera internet gateway or a BMS system\*\*

4 - Fuse

5 - PROG header, P1		Put a jumper onto pins 1 and 2 and wait for at least 5 seconds to reset the Modbus communication parameters
		Put a jumper onto pins 3 and 4 and restart the supply to enter bootloader mode

### Standards

- Low Voltage Directive (LVD) 2014/35/EC
  - EN 60529:1991 Degrees of protection provided by enclosures (IP Code) Amendment AC:1993 to EN 60529
  - EN 60730-1:2011 Automatic electrical controls for household and similar use - Part 1: General requirements
- Electromagnetic compatibility (EMC) Directive 2014/30/EC:
  - EN 60730-1:2011 Automatic electrical controls for household and similar use - Part 1: General requirements
  - EN 61000-6-1:2007 Electromagnetic compatibility (EMC) - Part 6-1: Generic standards - Immunity for residential, commercial and light-industrial environments
  - EN 61000-6-3:2007 Electromagnetic compatibility (EMC) - Part 6-3: Generic standards - Emission standard for residential, commercial and light-industrial environments Amendments A1:2011 and AC:2012 to EN 61000-6-3
- WEEE Directive 2012/19/EC
- RoHS Directive 2011/65/EC

\*Possible combinations can be found on our [website](#).  
\*\*We advise using the [CNVT-USB-RS485-V2](#) converter to connect RTVS8 to the USB port of your PC.



# RTVS8

115–230 VAC transformer fan speed controller with Modbus RTU

## Wiring and connections

### Terminal block

N	MOTOR	Regulated output to motor, neutral
L		Regulated output to motor, line
Pe		Protective earth terminal
N	RELAY	Unregulated output that can be activated manually via Modbus Holding register 15 or automatically according to the settings of Holding register 19
L		
N	INPUT	Power supply, neutral
L		Power supply, phase (230 VAC / 50–60 Hz)
TK		Input - TK monitoring for thermal motor protection
TK		

### 2 - RJ45 master socket - to connect a Sentera device for demand based fan speed control in automatic mode

Pin 1	24 VDC	Supply voltage
Pin 2		
Pin 3	A	Modbus RTU communication, signal A
Pin 4		
Pin 5	/B	Modbus RTU communication, signal /B
Pin 6		
Pin 7	GND	Ground, supply voltage
Pin 8		

### 3 - RJ45 gateway - to connect a computer with 3SModbus software, Sentera internet gateway or a BMS system

Pin 1		Do not connect to your computer
Pin 2		Do not connect to your computer
Pin 3	A	Modbus RTU communication, signal A
Pin 4		
Pin 5	/B	Modbus RTU communication, signal /B
Pin 6		
Pin 7		Do not connect to your computer
Pin 8		Do not connect to your computer

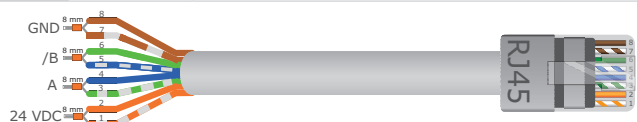

## Global trade item numbers (GTIN)

Article code	Unit
<b>RTVS8-15L22</b>	05401003018323
<b>RTVS8-25L22</b>	05401003018330
<b>RTVS8-35L22</b>	05401003018347
<b>RTVS8-50L22</b>	05401003018354
<b>RTVS8-75L22</b>	05401003018361

## Fixing and dimensions

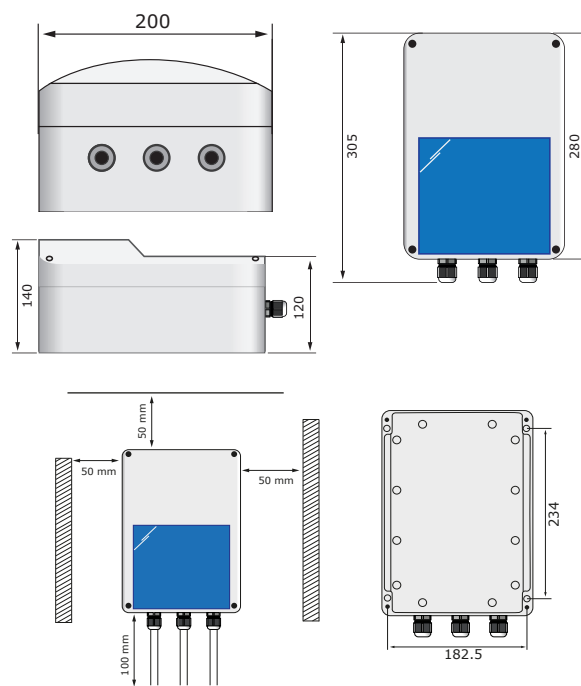

## Packaging

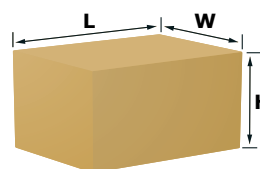

Article code	Packaging	Length [mm]	Width [mm]	Height [mm]	Net weight	Gross weight
RTVS8-15L22	Unit (1 pc.)	325	210	155	3, 5 kg	3, 9 kg
RTVS8-25L22	Unit (1 pc.)	325	210	155	4 kg	4, 4 kg
RTVS8-35L22	Unit (1 pc.)	325	210	155	5 kg	5, 4 kg
RTVS8-50L22	Unit (1 pc.)	325	210	155	5, 6 kg	6 kg
RTVS8-75L22	Unit (1 pc.)	325	210	155	7, 75 kg	8, 15 kg



# RTVS8

115—230 VAC transformer fan speed controller with Modbus RTU

## Application example 1: Manual mode - control via Modbus holding register 12



## Application example 2: Automatic mode - demand based ventilation (i.e. control via input from sensor)



## Application example 3: Automatic mode - control via analogue signal



## Application example 4: Automatic mode - control via a digital potentiometer

