

RSMFX-3

Multifunctional CO₂ room transmitter

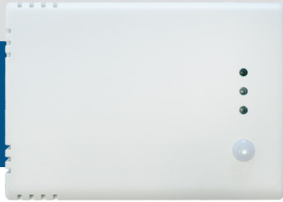

The RSMFX-3 series are multifunctional room transmitters which measure CO₂ concentration levels, temperature, relative humidity and ambient light. They have three analogue / modulating outputs for temperature, relative humidity and CO₂ and a wide range of low voltage power supply. Through Modbus RTU, all parameters are accessible.

Key features

- Selectable CO₂, temperature and relative humidity ranges
- 3 selectable analogue / modulating outputs
- A bootloader for firmware updates using Modbus RTU communication
- Ambient light sensor with adjustable 'active' and 'standby' level
- Modbus RTU communication
- 3 LEDs with adjustable light intensity for status indication
- Long-term stability and accuracy
- Spring clamp terminal blocks

Area of use

- Monitoring indoor temperature, relative humidity and CO₂ levels in HVAC applications
- Suitable for residential and commercial buildings
- For indoor use only

Article codes

Article code	Supply voltage	I _{max}	Connection type
RSMFF-3	24 VDC	80 mA	Terminal block
RSMFG-3	24 VDC	60 mA	
	24 VAC ±10%	120 mA	

Technical specifications

3 analogue / modulating outputs	0–10 VDC mode	min. load resistance 50 kΩ (R _L ≥ 50 kΩ)
	0–20 mA mode	max. load resistance 500 Ω (R _L ≤ 500 Ω)
	PWM (open-collector type) mode	1 kHz, min. load resistance 50 kΩ (R _L ≥ 50 kΩ), PWM voltage level: 3,3 VDC or 12 VDC
Typical range of use	Temperature	0–50 °C
	Relative humidity	0–95 % rH (non-condensing)
	CO ₂ range	400–2.000 ppm ±0,5 °C (5–50 °C) ±6 % rH (20–80 % rH)
Accuracy	400–2.000 ppm CO ₂	±(50 ppm + 3 % of the reading)
	2.001–5.000 ppm CO ₂	±(40 ppm + 5 % of the reading)
Protection standard	IP30 (according to EN 60529)	

How to configure



Via a Sentera Internet Gateway you can connect your installation to the SenteraWeb HVAC cloud and:

- Easily change the parameter settings of the connected devices remotely
- Define users and give them access to monitor the installation via a standard web browser
- Log data - create diagrams and export logged data
- Receive alerts or warnings when measured values exceed alert ranges or when errors occur
- Create different regimes for your ventilation system - e.g. day-night regime

The 3SMODBUS software platform allows for monitoring and configuring the unit's parameters.

You can download it from the following link:

<https://www.sentera.eu/en/3SMCenter>

Please refer to the Modbus Register Map of the product for more details regarding the Modbus registers.



Settings and indications

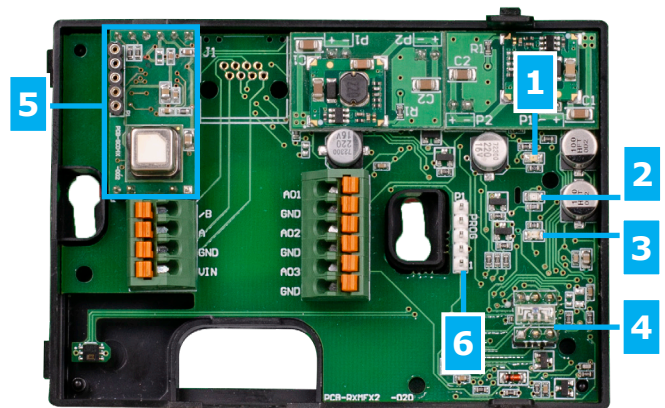

1 - Red LED	On	Measured temperature or relative humidity values are out of range or CO ₂ is higher than or equal to Alert 2 level
	Blinking	Communication with one of the sensors fails
2 - Yellow LED	On	Measured temperature or relative humidity values are in the alert range or CO ₂ is higher than or equal to Alert 1 level
	Blinking	Modbus communication has stopped and Holding register 8 is activated (Modbus timeout > 0 seconds)
3 - Green LED	On	Measured temperature or humidity levels are within range or CO ₂ level is lower than Alert 1 level
4 - Ambient light sensor		Low light intensity / Active / Standby
5 - CO ₂ sensor element		To measure CO ₂ concentration, self-calibrating
6 - PROG header, P1		Put a jumper on pins 1 and 2 and wait for at least 5 seconds to reset the Modbus communication parameters
		Put a jumper on pins 3 and 4 and restart the supply to enter bootloader mode

Note: By default, the LED indicators visualise the measured CO₂ level. When the sensor is in bootloader mode, the green and yellow LEDs flash alternately. During the firmware download, the red LED is flashing additionally.



RSMFX-3

Multifunctional CO₂ room transmitter

Wiring and connections

Article type	RSMFF-3	RSMFG-3	
VIN	24 VDC	24 VDC	24 VAC ±10%
GND	Ground	Common ground	AC ~
A	Modbus RTU (RS485) communication, signal A		
/B	Modbus RTU (RS485) communication, signal /B		
AO1	Analogue / modulating output 1 for temperature measurement (0–10 VDC / 0–20 mA / PWM)		
GND	Ground AO1	Common ground	
AO2	Analogue / modulating output 2 for relative humidity measurement (0–10 VDC / 0–20 mA / PWM)		
GND	Ground AO2	Common ground	
AO3	Analogue / modulating output 3 for CO ₂ measurement (0–10 VDC / 0–20 mA / PWM)		
GND	Ground AO3	Common ground	
Connections	Spring contact terminal blocks, cable cross section: 1,5 mm ²		

Attention! The -G version is intended for 3-wire connection and features a 'common ground'. This means that the ground of the analogue output is internally connected with the ground of the power supply.

The -F version is suited for 4-wire connection. It features separate grounds for power supply and analogue output. Never connect the separated ground of the -F article to other devices powered by an AC voltage. Doing so might cause permanent damage to the device!

Standards



- Low Voltage Directive 2014/35/EU
 - EN 60529:1991 Degrees of protection provided by enclosures (IP Code) Amendment AC:1993 to EN 60529
 - EN 60730-1:2011 Automatic electrical controls for household and similar use - Part 1: General requirements
- EMC Directive 2014/30/EU
 - EN 60730-1:2011 Automatic electrical controls for household and similar use - Part 1: General requirements
 - EN 61000-6-1:2007 Electromagnetic compatibility (EMC) - Part 6-1: Generic standards - Immunity for residential, commercial and light industrial environments
 - EN 61000-6-3:2007 Electromagnetic compatibility (EMC) - Part 6-3: Generic standards - Emission standard for residential, commercial and light-industrial environments Amendments A1:2011 and AC:2012 to EN 61000-6-3
 - EN 61326-1:2013 Electrical equipment for measurement, control and laboratory use - EMC requirements - Part 1: General requirements
 - EN 61326-2-3:2013 Electrical equipment for measurement, control and laboratory use - EMC requirements - Part 2-3: Particular requirements Test configuration, operational conditions and performance criteria for transmitters with integrated or remote signal conditioning.
- WEEE 2012/19/EU
- RoHs Directive 2011/65/EU
 - EN IEC 63000:2018 Technical documentation for the assessment of electrical and electronic products with respect to the restriction of hazardous substances

Operational diagrams

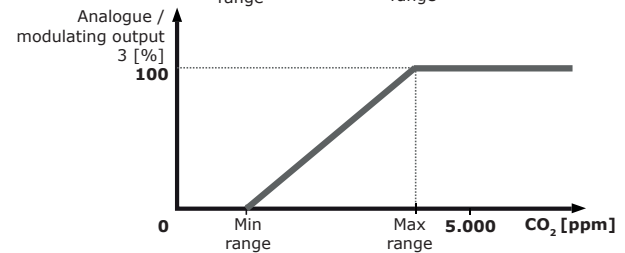
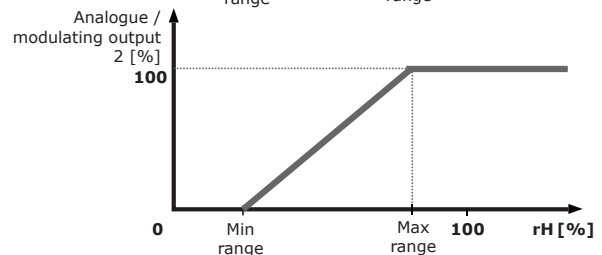
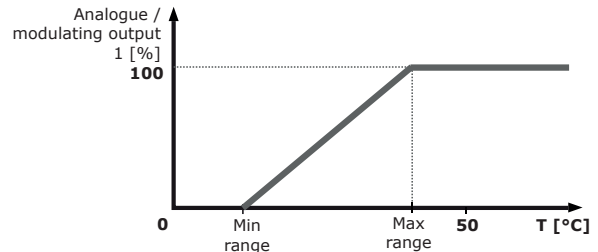

LED indication of CO₂ sensor (default setting)

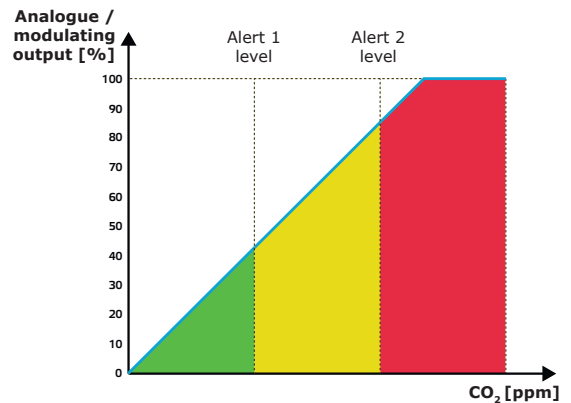

LED indication of temperature and humidity sensor

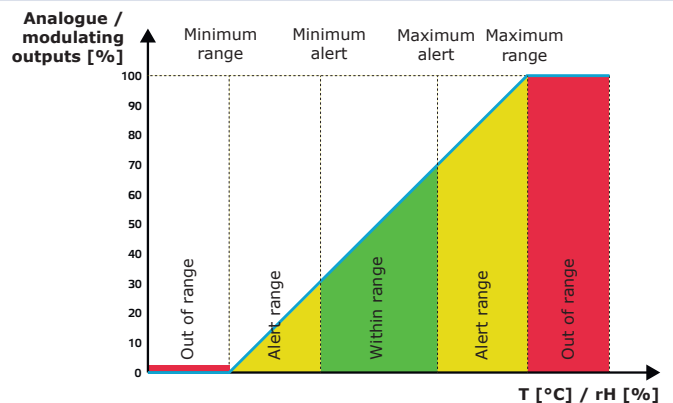



RSMFX-3

Multifunctional CO₂ room transmitter

Global trade item numbers (GTIN)

Packaging	RSMFF-3	RSMFG-3
Unit	05401003018842	05401003018859
Carton	05401003302934	05401003302941
Box	05401003504369	05401003504376

Fixing and dimensions

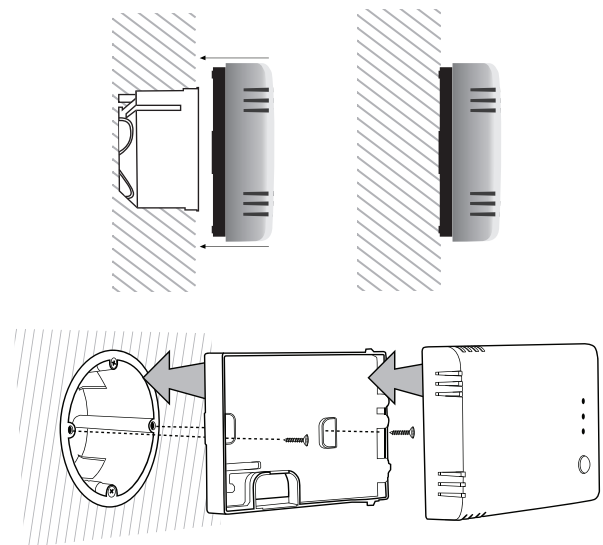
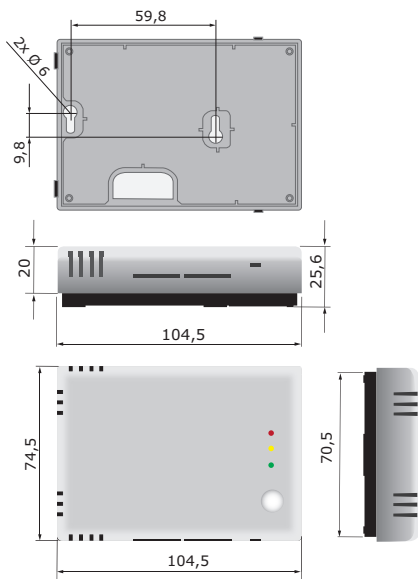

Packaging

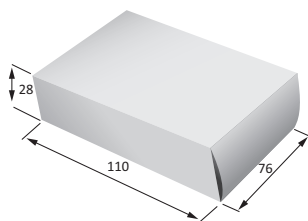

Article	Packaging	Length [mm]	Width [mm]	Height [mm]	Net weight	Gross weight
RSMFF-3 RSMFG-3	Unit (1 pc.)	110	76	28	0,095 kg	0,108 kg
	Carton (24 pcs.)	492	177	85	2,28 kg	2,742 kg
	Box (144 pcs.)	590	380	505	13,68 kg	17,442 kg