

DSTHX-3

Temperature and humidity duct transmitter

The DSTHX-3 series are dual duct transmitters which measure temperature and relative humidity. They feature a wide range of low voltage power supply and three analogue / modulating outputs. All parameters are accessible via Modbus RTU.



Key features

- Selectable temperature and relative humidity ranges
- 3 selectable analogue / modulating outputs: temperature, relative humidity and temperature or relative humidity
- Bootloader for updating the firmware via Modbus RTU communication
- Modbus RTU (RS485)
- Long-term stability and accuracy

Technical specifications

Analogue / modulating output type	0–10 VDC mode: min. load 50 kΩ ($R_L \geq 50 \text{ k}\Omega$)	
	0–20 mA mode: max. load 500 Ω ($R_L \leq 500 \Omega$)	
	PWM (open-collector type) mode: 1 kHz, min. load 50 kΩ ($R_L \geq 50 \text{ k}\Omega$), PWM voltage level: 3,3 VDC or 12 VDC	
Typical field of use	Temperature range	-30–70 °C
	Relative humidity range	0–100 % rH (non-condensing)
Accuracy	± 0,4 °C (range -30–70 °C)	
	± 3% rH (range 0–100 %)	
Min. airflow velocity	1 m / s	
Protection standard	Enclosure: IP54, probe: IP20	

Modbus registers



The Sensistart Modbus configurator allows you to easily monitor and/or configure Modbus parameters.

The parameters of the unit can be monitored / configured through the 3SMODBUS software platform. You can download it from the following link:
<https://www.sentera.eu/en/3SMCenter>

For more information about the Modbus registers, please refer to the product Modbus Register Map.

Standards

- Low Voltage Directive 2014/35/EC 
 - EN 60529:1991 Degrees of protection provided by enclosures (IP Code) Amendment AC:1993 to EN 60529
 - EN 60730-1:2011 Automatic electrical controls for household and similar use - Part 1: General requirements
- EMC Directive 2014/30/EC:
 - EN 60730-1:2011 Automatic electrical controls for household and similar use - Part 1: General requirements
 - EN 61000-6-1:2007 Electromagnetic compatibility (EMC) - Part 6-1: Generic standards - Immunity for residential, commercial and light-industrial environments
 - EN 61000-6-3:2007 Electromagnetic compatibility (EMC) - Part 6-3: Generic standards - Emission standard for residential, commercial and light-industrial environments Amendments A1:2011 and AC:2012 to EN 61000-6-3
 - EN 61326-1:2013 Electrical equipment for measurement, control and laboratory use - EMC requirements - Part 1: General requirements
 - EN 61326-2-3:2013 Electrical equipment for measurement, control and laboratory use - EMC requirements - Part 2-3: Particular requirements - Test configuration, operational conditions and performance criteria for transducers with integrated or remote signal conditioning
- WEEE Directive 2012/19/EC
- RoHS Directive 2011/65/EC

Article codes

Article code	Supply	Imax
DSTHG-3	18–34 VDC	70 mA
	15–24 VAC ±10%	80 mA
DSTHF-3	18–34 VDC	80 mA

Area of use

Monitoring duct temperature and relative humidity in HVAC applications

Wiring and connections

Article type	DSTHF-3	DSTHG-3	
VIN	18–34 VDC	18–34 VDC	15–24 VAC ±10%
GND	Ground	Common ground*	AC ~*
A	Modbus RTU (RS485), signal A		
/B	Modbus RTU (RS485), signal /B		
AO1	Analogue / modulating output 1 for temperature measurement (0–10 VDC / 0–20 mA / PWM)		
GND	Ground AO1	Common ground*	
AO2	Analogue / modulating output 2 for relative humidity measurement (0–10 VDC / 0–20 mA / PWM)		
GND	Ground AO2	Common ground*	
AO3	Analogue / modulating output 3 for temperature or relative humidity measurement (0–10 VDC / 0–20 mA / PWM)		
GND	Ground AO3	Common ground*	
Connections	Spring contact terminal blocks, cable cross section: 1,5 mm ²		

***Attention!** The -F version of the product is not suited for 3-wire connection. It has separate grounds for power supply and analogue output. Connecting both grounds together might result in incorrect measurements. Minimum 4 wires are required to connect -F type sensors.

The -G version is intended for 3-wire connection and features a 'common ground'. This means that the ground of the analogue output is internally connected with the ground of the power supply. For this reason, -G and -F types cannot be used together on the same network. Never connect the common ground of -G type articles to other devices powered by a DC voltage. Doing so might cause permanent damage to the connected devices.

DSTHX-3

Temperature and humidity duct transmitter



Settings

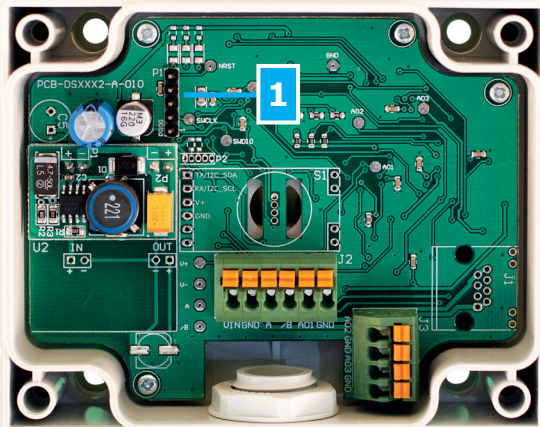

1 - PROG header, P1



Put a jumper onto pins 1 and 2 and wait for at least 5 seconds to reset the Modbus communication parameters



Put a jumper onto pins 3 and 4 and restart the supply to enter bootloader mode

indicates the position of the jumper)

Fixing and dimensions

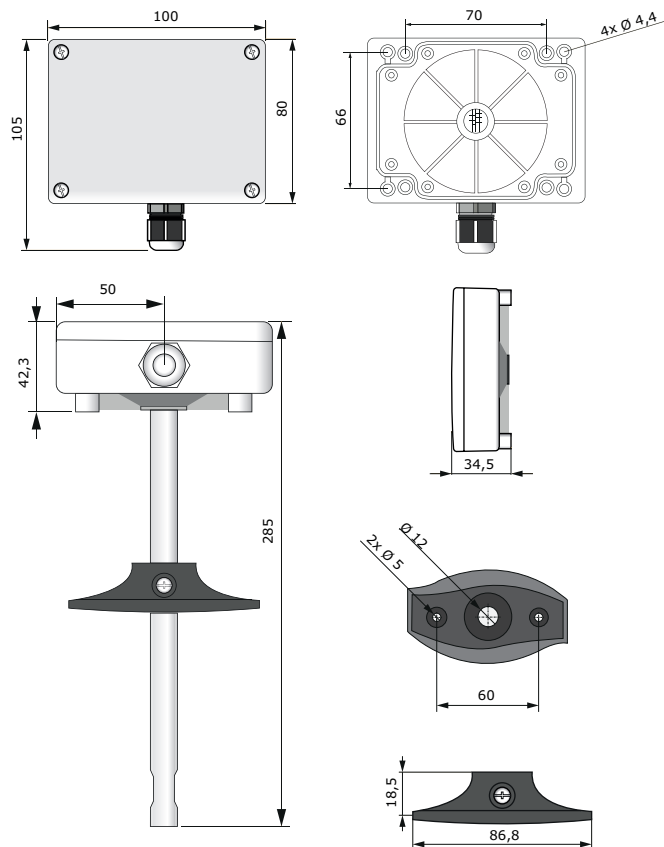

Operational diagram(s)

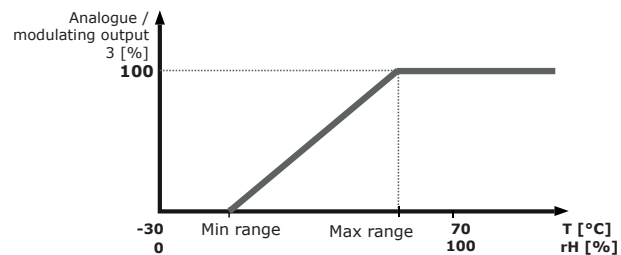
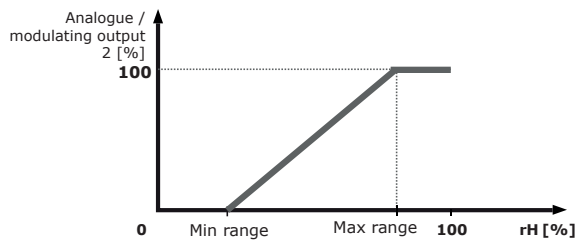
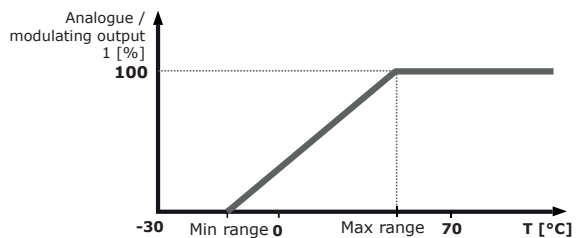

Packaging

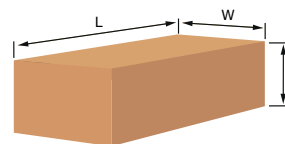

Article	Packaging	Length [mm]	Width [mm]	Height [mm]	Net weight	Gross weight
DSTHF-3 DSTHG-3	Unit (1 pc.)	310	115	115	0,15 kg	0,26 kg
	Box (20 pcs.)	590	380	505	3,00 kg	6,39 kg

Global trade item numbers (GTIN)

Packaging	DSTHF-3	DSTHG-3
Unit	05401003017685	05401003017692
Box	05401003503461	05401003503478